



2023

JULY 12-16
AUG 30-SEP 2

OVER 100 RACERS
EST 2009

LORING
RULES AND RECORDS
TIMING ASSOC

SPONSORED BY:



ii



Loring Timing Association

Rules and Records v. 2021

Covering Competition at LTA Speed Trials

The rules and / or regulations set forth herein are designed to provide for the orderly conduct of Speed Trial events and to establish **MINIMUM** acceptable requirements for such events. These rules shall govern the conditions of all events, and by participation in the same, all participants are deemed to have complied with these rules. **NO EXPRESSED OR IMPLIED WARRANTY OF SAFETY SHALL RESULT FROM PUBLICATION OF OR COMPLIANCE WITH THESE RULES AND/OR REGULATIONS.**

IT IS THE RESPONSIBILITY OF BOTH THE ENTRANT AND OPERATOR OF ANY RACE VEHICLE TO BE THOROUGHLY FAMILIAR WITH COMPLY WITH THE RULES HEREIN.

Any interpretation deviation, or imposition of further restrictions that do not alter the minimum acceptable requirements of these rules is left to the discretion of the Officials. Their decision is final. **NO EXPRESSED OR IMPLIED WARRANTY OF SAFETY SHALL RESULT FROM SUCH ALTERATIONS OF SPECIFICATIONS.**

Although a participant's vehicle meets all safety and technical regulations, the vehicle may not be allowed to compete due to environmental, course conditions or other considerations. All regulations are subject to change without notice; in the event of change, all prior inspections and classifications are nullified.

EVENT REGISTRATION

The completion of a registration form and payment for the same constitutes a binding transaction. No refunds are provided for failure to appear or a vehicle not passing technical inspection. It is the responsibility of each participant to arrive prepared. The sole remedy provided is the rolling of registration payment to the next event only with a written request received 2 weeks prior to the first day of the event.

Acknowledgements

Holding a Safe, Fun, and Fast LSR event is a major undertaking; an undertaking that would not be possible without the generous support of many. The wonderful experience that our races and spectators have at our events is only good as our volunteers. Their thankless hours of driving in stakes, crawling in and out of cars, and baking in the sun while directing traffic, and picking up trash can never be repaid. So, thank you for all of your generous help.

2021 Changes to Engine Classes - Wheelbases

We have changed the engine requirements for car classes to add all engine sizes and blowers to all Chassis classes. Classes with specific requirements are exempt from this change – i.e. Production (/PRO, PS), Real Street (RS), (AIR)roadster
Examples: A circle track (CT) may now run fuel, nitrous, and/or a turbo.

Mini Pickups (MP) may run any engine size up to AA.

We are also removing all wheelbase/engine size restrictions.

Race Director:

Joe Daly
(516) 860-8725
chevr55@aol.com

Event Director:

Tim Kelly
(207) 227-1693
Kelly_tim35@Hotmail.com

Car Tech Director:

Joe Daly
(516) 860-8725
chevr55@aol.com

Cycle Tech & E/V Director:

Frank John
(207) 266-5130
Biker_ev@yahoo.com

TABLE OF CONTENTS	Section:	Page:
General Competition Requirements		I 2
	Cars	
2 – Category/Class Overview		2 4
Competition Requirements and Specifications		
Engine Requirements		2.A 8
Tires		2.B 8
		2.H 9
3 - Technical Specifications and Requirements		
Driver Safety Equipment		3.A 10
Vehicle Safety Equipment		3.B 11
Fire Safety Equipment		3.Q 16
4 - Definitions		4 17
5 - Car Classes		
<u>Street Category</u>		5.A 20
Time Only – Street Car - Super Street - Real Street		
<u>Production Category</u>		5.B 21
Production Coupe & Sedan - Production Supercharged		
Grand Touring -		
<u>Roadster Category</u>		5.C 23
Street Roadster - Gas /Fuel Roadster - Modified Roadster -		
Rear Engine Modified Roadster		
<u>Modified Category</u>		5.D 26
Competition Coupe - Altered Coupe - Gas Coupe –		
Modified Sports - Circle Track		
<u>Classic Category</u>		5.E 30
Gas Coupe - Altered Coupe - Production Coupe & Sedan		
<u>Vintage Category</u>		5.F 31
Coupes & Sedans		
<u>Truck Category</u>		5.G 32
Pick-Up - Mini Pick-Up - Diesel Truck –		
<u>Special Construction Category</u>		5.H 33
Streamliner - Lakester - Electric - Turbine		
<u>Electric Category</u>		5.I 34
<u>36HP VW Category</u>		5.J 35
<u>Supercar</u>		5.K 35
6 - Records		6 36
	Motorcycles	
7 – OVERVIEW		7 45
<u>General Requirements</u>		7.A 46
Technical Specifications & Requirements		7.B 47
Riding Apparel		7.C 49
Frame Classes		7.D.1 49
Engine Classes		7.D.4 49
Motorcycle Classes		
Pure Production / Production		7.E 51
Modified		7.F 52
Altered		7.G 54
Streamliner		7.H 55
Sidecar		7.I 57
Sidecar Streamliner		7.J 58
Electric		7.K 58
8 - Records		8 59
200 MPH Club Members		78
APPENDIX I – FAA SAFETY WIRING GUIDE		82

GENERAL COMPETITION REQUIREMENTS

VEHICLE SAFETY

The primary responsibility for the safe condition and operation of a vehicle in compliance with all applicable rules and regulations rests with the vehicle's owner and driver. The main concern of the LTA is to provide a place to conduct events. The LTA produces guidelines based on experience and circulates information to help perpetuate the sport. Close observance of the minimum standards set forth in this rule book is an important fundamental.

1.A TECHNICAL AND SAFETY INSPECTION:

INSPECTIONS SHALL BE MADE USING THE CURRENT YEAR LTA RULE BOOK.

Each vehicle shall pass a Technical Inspection before being allowed to run. Cars competing above 175MPH shall be inspected by 2 inspectors and over 200MPH by 3 inspectors. Motorcycles competing above 150MPH shall be inspected by 2 inspectors and over 175MPH by 3 inspectors.

NO COMPETITOR SHALL BE REQUIRED TO MODIFY OR CHANGE ANY COMPONENT OR FEATURE OF A COMPETITION VEHICLE WITHOUT DIRECT CITATION OF THE RELEVANT RULE AND A CLEAR DESCRIPTION OF THE SPECIFIC INFRACTION FROM THE RULE BOOK. IN THE EVENT OF A DISPUTE BETWEEN THE INSPECTOR AND THE COMPETITOR THE ISSUE SHALL BE REFERRED TO THE DIRECTORS.

1.A.1 Logbook:

AN LTA LOGBOOK AND INSPECTION FORM IS REQUIRED FOR ALL TECHNICAL INSPECTIONS. For each event, the competitor must complete an "Event Record" section. The line entitled "Type of Vehicle" must include the make, model and year of the vehicle being raced. (Altered Category shall list engine manufacturer and frame builder.)

1.A.2 Vehicle Preparedness For Inspection:

VEHICLES PRESENTED FOR INSPECTION SHALL BE RACE READY. All technical inspections shall be made with all intended drivers present.

1.A.3 SAFETY EQUIPMENT:

Additional safety equipment or safety enhancing equipment is always permitted. The levels of safety equipment stated in the rule book serve only as the MINIMUM prescribed levels for competition.

1.A.4 Unsafe Vehicles:

Vehicles exhibiting poor handling on the course must be re-inspected and may be barred from further competition at the discretion of the Directors.

1.A.5 Open

1.A.6 Course Damage:

Any race vehicle or component thereof that could or has demonstrated a tendency to damage the race course may be barred until the vehicle or component is determined to be acceptable by the Chief Technical Inspector. Damage to the track, pit area, grounds, runway lights, or timing equipment caused by a race vehicle, component thereof, or race team, shall be the sole obligation of the registered racer deemed responsible for said damage.

1.B CLASSIFICATION:

It is the responsibility of the team to enter a vehicle in a proper class. To ensure records accuracy, any vehicle is subject to class verification and possible change by the Directors at any time.

1.B.1 Running Up In Class:

VEHICLES MAY RUN FOR RECORDS IN HIGHER ENGINE DISPLACEMENTS AND/OR BLOWN CATEGORIES THAN THEIR VEHICLE IS EQUIPPED WITH. CHANGES MUST BE MADE WITH REGISTRATION.

1.B.1 Class Changes:

Class changes are completed at registration prior to making the run. There is a \$50 fee. There is no fee for returning to a previously run class during the same meet. Vehicles must always display their current class.

1.B.2 Driver Changes:

Driver changes must be made at registration prior to an unregistered driver starting their pass. There is a \$50 fee for each new driver. There is no charge for registered driver changes.

1.B.3 Gas vs Fuel Class:

Gas class consists of:

- 1) Gas for racing purposes. Generally from a source such as VP.
- 2) Oxygenated Fuel
- 3) LP Gas
- 4) Diesel Fuel
- 5) Standard pump gas available at any filling station.

Fuel class consists most everything else:

Allowed:

- 1) Nitro- Methane, Ethanol, Nitrous Oxide.
- 2) Any Gas listed above.

Not allowed:

- 1) Alternate fuels. (See section 2C)

1.C STARTER:

An official starter and starting steward shall be appointed by the Directors and shall have the authority to bar a vehicle from the course even though it has passed inspection due to unsafe conditions.

1.D WEATHER:

The LTA assumes no responsibility whatsoever for delay, postponement, and cancellation of all or any part of an event because of inclement weather. Race officials may close the race course in whole or in part when the wind velocity at any point exceeds 15 MPH or any other adverse condition arises. FAILURE TO CANCEL ENTRIES AT LEAST 2 WEEKS PRIOR TO THE EVENT SHALL RESULT IN FORFEITURE OF ENTRY FEE.

1.E COURSE:

The overall straight-away course, conditions permitting shall be a maximum distance of 2.70 miles. Vehicles shall be timed at the 1.0 and 1.5 mile points.

1.F RESERVED

3

1.G RECORD CERTIFICATION:

All record breaking runs are certified electronically.

1.H ENGINE CERTIFICATION:

At the request of a race team, the LTA shall certify the engine displacement of a vehicle and indicate so in the record book. Following certification of the engine, a engine shall be wire sealed. The entrant is required to supply all measurement tools.

1.I PROTESTS:

1.I.1 Record Holding and Reversal:

When a new record is established and there is a question of legality of the vehicle, the Directors have the authority to hold or reverse the record.

1.I.2 Protest Time Period:

All protest must be made to the Directors prior to the close of the event and must provide tangible proof of a rule or class violation. The Directors shall rule within 30 days.

1.I.3 Engine Displacement Protests:

Engine displacement measurement may be made by the LTA or by protest. All engine protests require a fee of \$500 that is refundable if the protest is upheld or forfeit if the protest is denied. All costs shall be to the protesting party if the protest is denied and to the offending party if the protest is upheld.

1.I.4 Deviation:

Any deviation from the protest procedure may be considered at the discretion of the directors but may be ruled invalid due the inability to verify.

1.L PARTICIPANT CONDUCT:

1.L.1 Sober Operation:

Any participant who displays any signs of intoxication or drug use shall be barred immediately from that event. Additional penalties may be imposed.

1.L.2 Operating Safety:

Using the racecourse without authorization is prohibited. Driving any vehicle on the return road over 35 MPH is prohibited. Any reckless conduct by a race participant, i.e., doing warm-up passes without helmet or other required equipment or outside the designated warm-up area, more than one occupant in a race vehicle, failing to use a parachute at the end of a run or powering beyond the finish line may result in disciplinary action.

1.L.3 Unsportsmanlike Conduct:

Any unsportsmanlike conduct or disregard of rules and policies by an entrant towards an official, competitor, or spectator shall result in disciplinary action.

1.L.4 Chase/Push Vehicles:

Push trucks and chase vehicles must leave the starting area immediately following the vehicle they are recovering with lights on and travel at 65mph. Specific instruction shall be provided at the drivers meeting. Riding in the back of open pick-up trucks or speeding vehicles on the return road is prohibited.

FIRE EXTINGUISHER IN ALL PUSH TRUCKS/RECOVERY VEHICLES REQUIRED.

1.L.4 All-Terrain Vehicles/Scooters/Pit Bikes:

A: No foot pushing of vehicles allowed.

B: 4-Wheeler Rules:

- 1: Not allowed to tow cars.
- 2: Helmets to be worn at all times on return road.
- 3: 2 occupants in normal seating position only.

B: Side-by-Side Rules:

- 1: Seat belts to be worn at all times.
- 2: Occupants in normal seating positions only.

1.L.6 Pit Area:

Fire extinguisher shall be displayed in plain sight. Pit areas to be left as found.

1.M DRIVER REQUIREMENTS AND LICENSING:

A: All drivers/riders shall have a valid State or military issued driver's license.

B: A driver must be 18 years of age.

C: ALL NEW DRIVERS/RIDERS SHALL ATTEND A ROOKIE ORIENTATION MEETING PRIOR TO THEIR FIRST COMPETITION RUN.

D: All new drivers MUST make progressively faster passes in 25mph intervals. After each pass, the timing slip must be presented to the starter to endorse your "R" decal before your next incremental pass.

License categories are as follows:

Class	D	C	B	A	AA	U
Speed	<149	150	175	200	250	300

E: Experienced and professional (AMA, NHRA, BUB, FIM, NEDRA) drivers may be licensed at the discretion of the race director.

F: Licenses shall be reduced one category for each three years of inactivity.

1.M.1 ROOKIE ORIENTATION:

All new driver/riders are required to attend the MANDATORY rookie orientation for "R" decal endorsement. Should the driver/rider arrive after the meetings, a one-on-one orientation must be completed with a race official.

4

CARS

CARS OVERVIEW

(This overview is general and does not supersede any class rules)

This overview is designed to provide a general understanding of the categories and classes to help newcomers find the appropriate class for their vehicle. Cars are first broken down by CATEGORY and then CLASS. So, determine what CATEGORY your car shall fit into, then find the CLASS within that CATEGORY.

SPEED COSTS MONEY. . . HOW FAST DO YOU WANT TO GO?

	< 135	to-150	150-175	175-200	225+
CAGE	-	4-Point	6-Point	Full	Full
FIRE	-	-	1 - 5 lb.	2 - 5 lb.	2 - 5 lb.
CHUTE	-	-	-	1	1 or 2
BELTS	3-Point	SFI 16.1	SFI 16.1	SFI 16.1	SFI 16.1
HANS	-	-	-	-	Y
NET	-	Y or arms	Y or arms	Y	Y
ARMS	-	Y or net	Y or net	Y	Y
SUIT	Unblown	SFI / 1	(SFI / 5 - FIA 8856-2000)		
SUIT	Blown	SFI/5 + UW	SFI/5+UW	SFI/ 15	SFI/20 UW-fireproof underwear
SEAT	Street	Street	Race	Race	Race

STREET CATEGORY

Time Only (T/O)

Time only is for vehicles that meet the safety requirements for their intended speed but 1) do not fit into a class, or 2) do not wish to run for records.

Super Street (SS)

- A: Designed for more modern vehicles and some older.
- B: Fuel injected, supercharged, and turbos allowed.
- C: Nitrous Oxide allowed.
- D: Body kits put many vehicles into SS class.
- E: Almost any street car will fit this class.

Real Street (RS)

- A: Designed for normally carbureted vehicles only.
- B: No more than 4 TOTAL BARRELS allowed.
- C: Gas and Fuel class only

PRODUCTION CATEGORY

This category is intended to represent typical transportation vehicle.

Production Coupe & Sedan - /PRO

- A: American cars 1982-present.
- B: Foreign cars from 1949-present.
- C: American cars from 1928-1981 that do not meet CLASSIC.
- D: Original seating for 4 required. (El Camino and Ranchero allowed.)
- E: Body, frame, wheelbase cannot be altered in any way.
- F: No engine swaps.

Supercharged - /PS

- A: Production (above) with factory Supercharger or Turbo.

Grand Touring - /GT, /BGT

- A: Production car as above.
- B: Two seating position. (Corvette, Viper, Honda S2000)
- C: Engine swaps ARE allowed.

ROADSTER CATEGORY

Street Roadster - /STR, /BSTR

- A: Minor body modifications allowed.
- B: Hood stretch of 3" allowed.
- C: No streamlining or changes to the body contour allowed.
- D: Rear fenders required.

Gas- Fuel Roadster - /GR, /BGR, /FR, /BFR

Basically a Street Roadster with more modifications allowed.

- A: Some body modifications allowed.
- B: Hood stretch to 143" inch body length allowed.
- C: Hood shaping Some streamlining allowed.

Modified Roadster - /GMR, /BGMR, /FMR, /BFMR

- A: Wheelbase stretched to 90 – 190"
- B: Minor body and Streamlining modifications allowed.
- D: Engine and driver relocation allowed.

Rear Engine Modified Roadster - /GRMR, /BGRMR, /FRMR, /BFRMR

- A: Wheelbase of 140 – 190"
- B: Considerable streamlining and body modifications allowed.
- C: Considerable.

MODIFIED CATEGORY

This category encompasses American and foreign coupes and sedans. The amount of modification to the vehicle determines the class.

Gas Coupe and Sedan - /GC, /BGC

- A: Production class (/PRO) with one of the following modifications.
 - 1: Engine Swap and/or Quick-change rear end
 - 3: Non-stock supercharger or turbo
- B: No streamlining or changes to the OEM bodywork allowed.
- C: Convertibles must run in Gas Coupe or Production.

Competition Coupe - /GCC, /BCC, /FCC, /BFCC

- A: Production class (/PRO) with one of the following modifications.

- 1: Chopped top, Full belly pan and Lengthened front body allowed
- 4: Engine setback 25 – 50% of wheelbase.

Modified Sports - /GMS, /BGMS, /FMS, /BFMS

- A: GT Class cars (Production Grand Touring) that have been modified.
- B: Considerable streamlining and body modification allowed.
- C: Custom and stretched frames allowed.
- D: Engine location change allowed.

Altered Coupe - /GALT, /BGALT, /FALT, /BFALT

- A: All coupes and sedans from 1928 – present.
- B: No streamlining or changes to the OEM bodywork allowed.
- C: Production class (/PRO) with one of the following modifications.
 - 1: Addition of a step pan.
 - 2: Engine setback of 25%.
 - 3: Front wheel drive converted to rear wheel drive.
 - 4: Covered head lights and grill per rules.

Circle Track - /GCT, /FCT, /VCT

- A: NASCAR, SCCA, IMSA, etc.
- C: All fuel and engine types allowed.

CLASSIC CATEGORY

CARS FROM 1928-1981 ONLY.

This category encompasses vehicles from the "Golden Age" of American cars. The spirit of the class is older cars running carburetors and a distributor.

- A: Limited modifications to the historical body lines allowed.
- B: Altered and Production class rules are used for the allowed modifications.
- C: Original seating for 4 required. (El Camino and Ranchero allowed.)
- D: NO non-OEM EFI or engine management.
- E: One distributor or magneto allowed.
- F: CLASSIC rules are the same as their PRODUCTION class. (/CPRO-/PRO).

6

VINTAGE CATEGORY See Rules.

TRUCK CATEGORY

Production Pickup Truck - /PP

- A: 1946-present American FULL SIZE pickup trucks.
- B: No streamlining or changes to the OEM bodywork allowed.
- C: Rules are as in Production Coupe and Sedan Class (/PRO).

Production Mid/Mini Pickup Truck - /PMP

- A: 1972 and newer mid/mini pickup with stock bed.
- B: Same rules as Production Pickup /PP above.

Modified Pickup Truck - /MP

- A: 1948 – present American pickup trucks with stock bed.
- B: Gas Coupe (GC) rules apply to this class.
- C: One of the following modifications is required.
 - 1: Engine Swap
 - 2: Quick change rear end
 - 3: Non-stock supercharger
- D: No streamlining or changes to the OEM bodywork allowed.

Modified Mid/Mini Pickup Truck - /MMP, /BMMP

- A: 1972 and newer mid/mini pickup with stock bed.
- B: Same rules as Modified Pickup /MP above.

Diesel Truck/Modified Diesel/Unlimited Diesel - /DT /MDT /UDT

See Rules.

SPECIAL CONSTRUCTION See Rules.

ELECTRIC See Rules.

36hp Challenge See Rules.

SUPERCARS See Rules.

COMPETITION REQUIREMENTS AND SPECIFICATIONS APPLIES TO ALL VEHICLES

2.A NUMBER/CLASS DESIGNATION:

SCTA numbers shall be accepted at LTA events. LTA numbers (XXXX) shall be assigned to vehicles that do not intend to run in SCTA/USFRA/ECTA events. Numbers must be a minimum of 3 in. high. The current class designation shall appear on the race vehicle adjacent to the number.

2.B ENGINES:

Any internal combustion engine using either a two stroke or four stroke Otto cycle or diesel cycle may run in any category, except Vintage.

Engines that only transmit the power through the wheels may run. Only Streamliners and Unlimited Diesel Trucks may use more than one engine.

2.B.1 VINTAGE ENGINES:

Vintage engine classes refer to block or crankcase and are intended to be representative of examples. In XF, XO, XXF, XXO, V4 and V4F classes, non-production engines or after-market blocks (even though they accept production crankshafts, cams and cylinder heads) may not be used. Competitors are required to use production or factory authorized replacements and shall retain all original dimensions except as follows: Cylinder bore centers deck material, height, and thickness shall be maintained to within .150" of original design, excepting modifications involving intake/exhaust ports, cooling ports and specialty head adaption.

XF class consists of any production FORD/MERCURY, passenger car V-8 flathead engine, 1932 through 1953, up to 325 cid.

XO class consists of overhead valve and flathead inline and flathead V8 (except Ford & Mercury) and V12 engines, 1959 or earlier design, up to 325 cid.

XXF is an XF engine as above with a specialty cylinder head as below.

XXO is an XO engine, as above with a specialty cylinder head as below.

A specialty cylinder head is fabricated billet, cast or a modified OEM head that has added ports. At least one valve per cylinder must be in the head. All X class engines, as described above, which are over 325 cid but less than 375 cid shall be classified as either XXF or XXO.

Overhead cam specialty cylinder heads are not allowed in the XF, XO, XXF, & XXO engine classes. XX/PRO class is limited to cylinder head port configuration as originally designed. This applies to the XXF and XXO engine classes.

Vintage Four (V4) class consists of any pre-1935 American made four-cylinder automotive production engine, up to 220 cid. Specialty heads are allowed. The Vintage Four (V4) engine class is allowed in Special Construction, and Vintage categories only. NOTE: See exception under Rules for Vintage Oval Category.

Flathead Vintage Four (V4F) consists of any pre-1935 originally designed and American made flathead four-cylinder automotive production engine, up to 220 cid. The engine shall have been produced as a valve in block engine, with the camshaft in the same location as produced. Only flathead type cylinder heads are allowed. No specialty OHV or OHC conversion heads allowed.

For reasons of economy and historical authenticity, vintage engine modifications are restricted to older technology levels, so far as is practical. Accordingly, in classes XO, XF, XXF, XXO, and V4 & V4F, using Vintage bodies:

2.B.2 ENGINE CLASS SIZES

Ω (O) Omega Engines using a thermodynamic cycle other than Otto
Cubic Inch Displ. Liter Equiv.

AA	501.00 cid and over	8.210 liters and over
A	440.00 to 500.99 cid	7.210 to 8.209 L
B	373.00 to 439.99 cid	6.112 to 7.209 L
C	306.00 to 372.99 cid	5.015 to 6.111 L
D	261.00 to 305.99 cid	4.277 to 5.014 L
E	184.00 to 260.99 cid	3.015 to 4.276 L
F	123.00 to 183.99 cid	2.016 to 3.014 L
G	93.00 to 122.99 cid	1.524 to 2.015 L
H	62.00 to 92.99 cid	1.016 to 1.523 L

I	46.00 to 61.99 cid	0.754 to 1.015 L
J	31.00 to 45.99 cid	0.508 to 0.753 L
K	up to 30.99 cid	0.507 L and under

2.C FUELS: (see 1.B.3 as well)

(G) GAS is defined as racing gasoline, oxygenated gasoline, standard pump gas, LP gas, or diesel fuel. Nitrous Oxide is not allowed.

(F) FUEL is defined as any approved fuel sources such as nitro-methane, alcohol, and hydrogen. Any oxidizer such as Nitrous Oxide is also considered Fuel. ALL GAS CLASS (G) LISTED ABOVE MAY ALSO BE RUN IN FUEL CLASS BY SIMPLY CHANGING CLASSES FROM GAS TO FUEL.

(AF) Alternate fuel is defined as liquid or gaseous fuels not defined above. Alternate fuels shall include propane, hydrogen, soybean/corn oil etc. The fuel designation is made a fuel class: i.e. /AFSS = Alternate Fuel Super Street.

(E) Electric is defined as propulsion via electric motors only. Electric power is designated in the LTA records as a fuel class: /ESS = Electric Super Street.

2.D FRAMES/CHASSIS:

Except where forbidden by class rules, any design frame may be used. The frame design is subject to the approval of the Race or Event Director.

2.E SHOCKS:

A functional shock absorber is required for each sprung wheel.

2.F DRIVE HUBS:

Any car equipped with a non-retained axle bearing (non-Hotchkiss type rear axle, front wheel drive hubs and four wheel drive hubs) assembly shall incorporate an approved hub to prevent loss of a wheel in the event of an axle failure. Semi or full floating rear axle assemblies, as used in most late model production cars, are sufficient. Late model GM type rear ends using stock "C" clip axle retainers are NOT acceptable.

2.G FOUR WHEEL DRIVE:

Four wheel drive is allowed in Special Construction Category and Production Category where the vehicle was originally equipped with four wheel drive.

2.H TIRES:

A: Drag slicks are not allowed.

B: Tubeless tires must use metal valve stems and caps.

C: Adequate tire clearance between the tire and body or chassis is required.

D: Tire speed rating is determined by the speed the vehicle intends to run.

E: Any tire deviation must be submitted to the technical director.

The use of non-rated tires such as farm, aircraft or reproduction vintage, 17" Drag tires, or non-pneumatic tires must be approved.

These minimum tire requirements will be observed by LTA inspection officials:

Up to 125 MPH: Original equipment tire QR & RR

Up to 150 MPH: SR, TR or UR rated tires

Up to 175 MPH: HR rated tires

Up to 250 MPH: NASCAR spec Speedway tires.

Over 250 MPH: Specialty or Land Speed tires.

2.I WHEELS:

NONFERROUS WHEELS where lug nuts come in contact with the wheel shall have a 1/4" thick steel retaining plate or large OD washers under lug nuts.

MAGNESIUM WHEELS, if used, shall have a Zyglo certificate and stamp.

ALL CLASSES UNDER 200 MPH: The smallest part of the hex of a lug nut must be larger than the largest part of the taper of the mounting hole. A minimum of 5/8 in. of the stud threads must be engaged within the lug nut.

CLASSES OVER 200 MPH: 1" lug nuts are required on all vehicles. Wheels used must be manufactured for racing or reinforced as below. Wheels must be attached with at least 5 studs with a minimum dia. of 1/2". and 1" lug nuts.

REINFORCEMENT SHALL BE DONE by welding the entire area of attachment between the rim and the center section on either the side of the wheel.

WIRE WHEELS: Wire wheels designed for automotive racing applications are allowed. Automotive OEM wire wheels are not allowed without approval.

NOT ALLOWED:

A: No closed end (Acorn type) lug nuts are allowed.

C: Hubcaps.

D: Fender skirts are not allowed, except in Streamliner class. The prohibition against "wheel covering" in some class rules does not apply to "full wheel" discs which are legal if securely fastened to the wheels with 6 or more machine grade screws or 3 Dzus type fasteners. Inner wheel discs shall be mounted to the wheel or axle.

2.J TRACK:

Track is defined as the measurement from the centerline of one tire to the centerline of the opposite tire of paired wheels. The minimum track dimensions for all Vintage Category vehicles are 44 in. front and 50 in. rear.

2.K PUSH BARS:

All cars incapable of starting under their own power shall be equipped with bumpers or push bars. Push bars shall not offer any aerodynamic advantage. No horizontal paneling is allowed between the rear of the body and the bumper/push bar. No towed starts are permitted without approval.

2.L BALLAST:

Ballast may be used in all categories. Ballast shall be securely mounted, bolted to the frame or the frame structure. Ballast shall not be used to streamline the vehicle, see Section 4.CC.

2.M REPLICA BODIES AND PANELS:

Replicas of original stock bodies and panels may be used in categories provided they are exact dimensional replicas of factory production units that are otherwise acceptable in the category.

2.N CANOPIES:

Canopies enclosing the driver are permitted in Special Construction classes only. The canopy shall be securely closed by the employment of a mechanical fastening. Canopies shall be capable of being opened from inside and out without tools. Latches must be clearly marked on the outside.

2.O TARPULINS AND TONNEAU COVERS:

Cockpits may be covered with any nonflammable material and may be flexible or rigid unless otherwise stated in the class rules.

2.Q DATA RECORDERS:

Entrants in all classes may use a data recorder.

9

Section 3

DRIVERS SPECIFICATIONS AND REQUIREMENTS

3.A MINIMUM DRIVER'S APPAREL:

3.A.2 All Other Drivers:

All drivers must wear a driver's suit, gloves, SFI 3.3 HEAD SOCK OR HELMET SKIRT, and boots. All items shall be in serviceable condition with SFI/FIA tag attached. Protective underwear is recommended and it is advisable not to wear synthetic clothing under the driver's suit.

3.A.3 Minimum Driver's Suit Requirements:

Type of Vehicle

Unblown closed cars to 150 MPH

Suit SFI 3.2A/1

Boots SFI 3.3/5

Gloves SFI 3.3/5

Head sock SFI 3.3

Unblown, open cars under 200 MPH and

Unblown, closed cars between 150 MPH and 200 MPH

Suit SFI 3.2A/5 FIA 8856-2000

Boots SFI 3.3/5

Gloves SFI 3.3/5

Head sock SFI 3.3

Blown cars, open or closed under 200 MPH and

Unblown, open or closed over 200 MPH

Suit SFI 3.2A/15 or 3.2A/5 with fireproof underwear

Boots SFI 3.3/5

Gloves SFI 3.3/15

Head sock SFI 3.3

Blown cars, open or closed over 200 MPH

Suit	SFI 3.2A/20
Boots	SFI 3.3/15
Gloves	SFI 3.3/15
Head sock	SFI 3.3

3.A.2 Driver's Helmet:

- A: All drivers/riders must wear a full-face helmet with face shield.
- B: Helmets shall be certified to the end of their SNELL lifecycle plus 1 year.
- C: Helmets are inspected at each meet to ensure serviceable condition
- D: A Snell Foundation tag reading Snell SA 2015, or 2020 is required.
- E: Snell rating of 2015 shall be dropped after 2026.
- F: All enclosed cockpit cars and motorcycles, require SA rated helmets.
- G: Eyeglasses worn under the helmet must be shatterproof.

3.A.3 Driver's Helmet Support:

- A: Forward Movement: All cars over 200 mph shall have an engineered and tested SFI spec 38.1 type head and neck restraint system.

3.B ROLL CAGES AND ROLL BARS:

Cars between 150 and 175 MPH must have a 6-point roll bar.

Cars over 175 MPH must have a full roll cage.

Open cars are advanced one cage category over closed cars.

Mild steel tubing is recommended for the construction of roll cage structures. All joints shall be welded. All bolts shall be 3/8" and minimum of grade 5.

All bolted structures must have at least two bolts (90 degrees apart) through support pads or welded sleeves.

On unitized and monocoque cars, roll cage and braces must have 1/4" thick support pads on the top and bottom of the floor. Cars under 2500 lbs. shall have pads of at least 18" perimeter and over 2500 lbs. at least 22" perimeter.

Any deviation from these rules must be approval.

3.B.1 ROLL CAGE SIZING:

J, K & L Classes - Minimum requirements for cage structure is steel tubing not less than 1 1/4" OD x .095" nominal wall thickness.

G, H & I Classes - Minimum requirements for cage type is steel tubing not less than 1 1/2" OD x .095" nominal wall thickness.

All Other Classes - Minimum requirements for cage structure is steel tubing is 1 5/8" OD x .120" nominal wall thickness.

Securely mounted, gusseted and braced within 5" of the top of the roll cage structure. All cage structures must be designed to protect the driver from any angle including the bottom. Any vehicle exceeding 175 MPH must use the larger tube minimum requirements.

Minimum 5 point roll cage is required if the hoops and bars are mounted to the shoulder bar as in a lakester or roadster cage. The roll cage bars must be supported, cross braced and gusseted to prevent forward or lateral collapse.

3.B.1.1 Gussets:

Gussets are required at tube junctions of hoop and shoulder bar rail. Gussets shall either be made of steel .125" plate or 1 x.120" tubing as a minimum.

Plate gussets shall be four inches per side preferably stitch welded on the outside of the tube junction.

Tube gussets shall be constructed such that the outside edge is at least 4" from junction points. See Figures 2, 3, 4, and 5. It is recommended that tube gussets be of the same O.D. and wall thickness as the main roll cage.

Not Allowed:

- A: Gussets shall not exceed 6" in. in length.
- B: Grinding of welds.
- C: Gussets may not act as aerodynamic aids.

3.B.1.2 Head Protection:

The front hoop of the roll cage shall be at least three inches in front of the driver's helmet while the driver is position. When a Full Containment seat is not utilized, A lateral structure (see Section 3A.3) shall be constructed such that the helmet cannot exit the roll cage. It must be a minimum width of one inch wide and a minimum .125 inches thick mild steel. It must be securely welded to the roll cage. (See Figure 5).

For vehicles over 200mph, driver head movement must be limited to no more than 2 in. to each side, top, or rear with driver's head in the normal position. Roll cage padding meeting SFI specification 45.1 for round tube roll cage padding and SFI specification 45.2 for flat roll cage padding is required

3.B.1.3 Deviation:

Deviation requests must be submitted no less than 45 days prior to the event.

3.B.2 Roll Bars: (Fig 1)

G, H, I, J & K classes. See 3.B.1 G,H&I Classes.

All Other Classes – See 3.B.1 All other classes. 1 3/4" OD tubing required.

3.B.2.1 Head Clearance:

All roll bars must come within 6" of the rear or side of the driver's head extend above the driver's helmet with the driver in the normal driving position.

3.C Head Rest:

A padded headrest shall be installed in all vehicles to prevent whiplash. All drivers shall have the padding within 2 in. of the back of helmet.



Figure 1a
Example of Roll Bar
Construction.

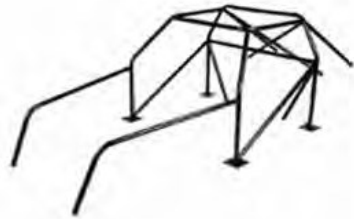

Figure 1b
Example of Roll Cage
Construction.

11

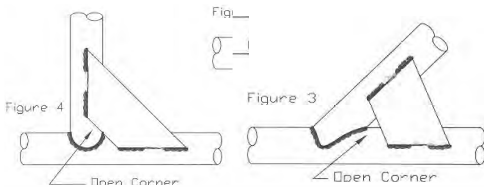

Figure 5

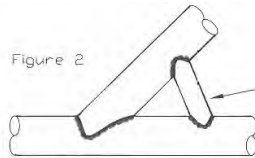

Figure 6

Figure
2, 3, 4
Gussets

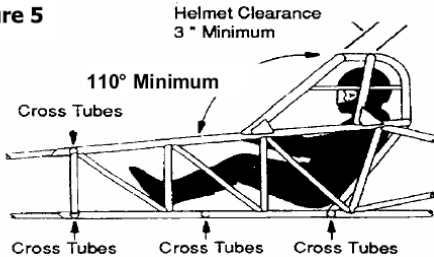

Figure 8

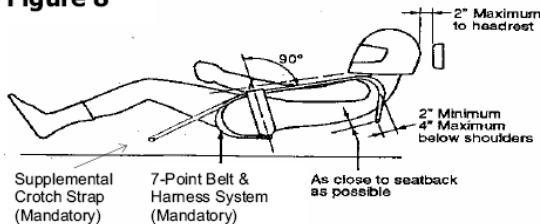
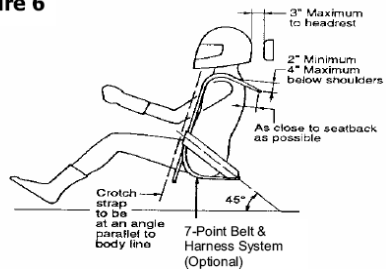
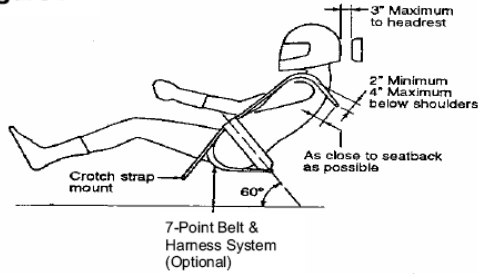

Figure 7



3.D DRIVER RESTRAINTS

3.D.1 Seats:

All vehicles over 150 MPH require a seat designed for racing. The seat shall be made of a metal, alloy sufficient to retain the driver under high G loading. Composite seats must be preapproved by the technical committee. The seat shall be securely fastened and have a maximum of 1 in. padding. Sprung or compressible seats are prohibited. Seats shall be securely installed and braced.

3.D.2 Seat Belts:

A: Under 135 MPH – 3 point lap and shoulder belt.

B: Over 135 MPH - SFI specification 16.1 or 16.5, quick release, competition type seat belts and shoulder harness with 2 in. minimum lap and shoulder belts and 2 in. crotch strap are mandatory in all categories. All seat belt and shoulder harness installations shall be originally designed to be used with each other. All belts shall be in good condition and have a manufacturer's tag not more than 5 years old on the label. When arm restraints are an adequate protective cover shall be installed over "latch lever" mechanism to prevent the arm restraint from releasing the latch lever.

Seat belts and harnesses shall be installed to both the manufacturer and helmet support system requirements. Through the floorboard mounting is not permitted without additional reinforcement. Mounting shall be accomplished with a minimum of grade 5 bolts. The shoulder harness must be mounted in a manner as to prevent slipping off the driver's shoulders. See fig. 6, 7, and 8.

In a vehicle with minimal cockpit room, seat belt tighten pull is to the center of the vehicle, see figure 9.

3.D.3 Arm/Leg Restraints:

A: Under 135MPH – No Requirement.

B: 135 MPH - 175 MPH: Arm restraints OR a full door net required.

C: 175 MPH and over: Arm restraints AND a full door net is required.

D: SFI 3.3 arm restraints with a date of 2006 or later are required.

E: Arm restraints shall be released in conjunction with driver's belts.

F: Participants are cautioned that all controls be mounted as close to the steering wheel as possible to keep all arm restraints as short as possible.

G: Legs shall be restrained by tethers, panels (non-body), bars or net.

H: The restraint system shall prevent the driver's limbs from exiting the roll structure and/or frame rails in an incident that includes panel separation.

I: All mounting tabs/brackets shall be mounted inside the outer plane of the roll structure in a manner that in an incident they do not come into contact with the racing surface or the driver's body.

J: Nets shall be mounted in a manner that they fall out of the driver's way.

K: Nets shall be mounted so that the driver can exit the car unassisted.

L: Only the manufacturer shall perform modifications to window nets.

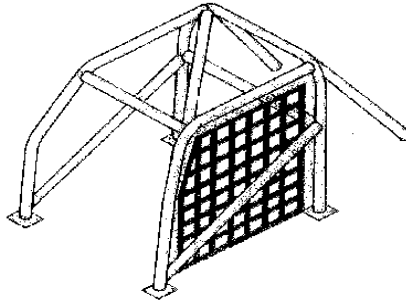
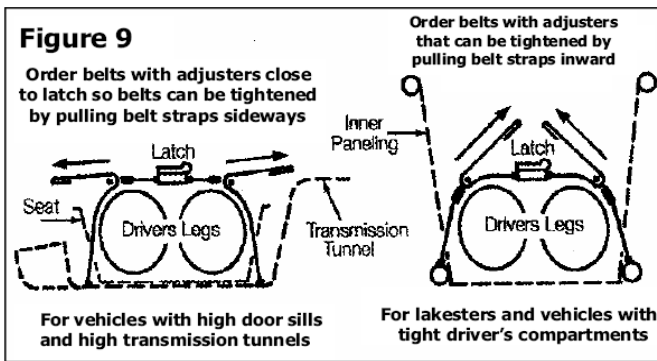

Figure 10

13

3.E DRIVER'S COMPARTMENT:

Vehicle shall be arranged to provide 120 degrees of forward vision. The driver must be able to exit the compartment with ease. All doors, hatches, and canopies must be opened from inside and outside of the vehicle without tools. Driver's compartments shall not be open to the exterior in a manner which creates a hazard to the driver. A rear floor or aft bulkhead is required in all vehicles where applicable. The driver's compartment shall be free from sharp edges, protrusions, brackets, etc. within close proximity of the driver. Non-OEM latches shall be clearly marked on the outside of the vehicle.

On closed cars, door locks and steering wheel locks shall be rendered inoperative. All enclosed driver compartments shall be equipped with a forward-pointing fresh air intake or breathing system directed to the driver and have adequate venting to carry away fumes. COMPRESSED OXYGEN BREATHING SYSTEMS ARE PROHIBITED.

3.F FIREWALL:

All non-stock firewalls shall be made of metal with a minimum thickness of .060 in. (.095 recommended). All holes must be sealed.

3.G SECONDARY FLOORING:

All cars with modified floor pans shall have secondary flooring. The secondary flooring must be securely attached to the frame or cross member. Expanded metal shall be accepted if sufficiently rigid. Except in Vintage Oval Track Class, secondary flooring shall be no lower than the bottom of the frame plus the thickness of material used.

3.H TRANSMISSION SHIELDS:

All cars over 135 MPH, with automatic or planetary type transmissions shall be equipped with a ballistic transmission blanket or approved shield. It is recommended that the transmission blanket/shield meet SFI specification 4.1.

3.H.1 TRANSMISSIONS:

Any type of transmission may be used in any class.

3.I FUEL SYSTEMS:

The complete fuel system shall be securely mounted. Plastic fuel lines are not permitted. A metal screw type clamp shall be on each connection of rubber or steel-braided fuel line. All components of the fuel system shall be isolated from the driver's compartment. All fuel lines in the area of the clutch and flywheel shall be run through heavy steel tubing or outside the frame rail, regardless of the presence of a scatter shield.

All fuel tanks shall be vented and provisioned to eliminate spillage. All fuel tanks shall be isolated from the driver's compartment and protected in the plane of the blower drive, if used.

3.I.1 Fuel Shut-off:

All cars with other than stock fuel system shall have a fuel shut-off within the driver's reach. Electric fuel pumps shall have a switch and inertia switch in the circuit to disable pump operation. All rotating fuel shut-off valves MUST have a positive stop to prevent reopening of the valve.

3.I.2 Nitrous Oxide Systems:

Nitrous Oxide bottles and lines are considered a portion of the fuel system and governed by all fuel system requirements. Nitrous Oxide bottles shall be securely mounted. Nitrous Oxide systems shall be visibly identified as such and the location of the bottle(s) shall be indicated on the exterior of the vehicle.

Nitrous Oxide cylinders may be mounted inside the driver's compartment.

THE NITROUS OXIDE BOTTLE PRESSURE RELIEF VALVE SHALL BE VENTED TO THE OUTSIDE OF THE VEHICLE BY A RIGID LINE.

3.J THROTTLES:

All cars shall be equipped with a redundant, self-closing throttle control with 2 adequate return springs. There must also be a positive stop. Accelerator pedal toe straps are required, except on OEM cable or hydraulic throttles.

3.K BATTERIES:

All batteries shall be properly secured with metal framework and fasteners. Batteries may be mounted in the driver's compartment if sealed in a spill-proof box. Glass Mat or Dry cell type batteries (Optima, Odyssey, etc.) are exempt.

All vehicles over 135 mph shall be equipped with an exterior battery disconnect switch. The disconnect switch or a control (cable or rod) for the switch shall be located on the rear of the vehicle and clearly marked.

3.L STEERING:

All steering systems shall be gear or link type securely mounted in a workmanship like manner with regard for clearances.

All spherical ends (i.e., Heim) used in steering systems shall be steel and shall have washers with a larger OD than the Heim (solid type Heim joints are required). All bolts must be at least grade 5. For vehicles with long steering shafts, the shaft shall be collapsible or have a secondary shaft stop installed.

The use of wagon wheel type steering on front wheel drive vehicles, cable steering and non-metallic steering wheel hub releases are not allowed.

3.M PARACHUTE:

A: 175-225 MPH – A single parachute is required.

B: 225+ MPH and 2 wheel brakes – Two independent parachutes required.

C: 250+ MPH with 4 wheel brakes - Two independent parachutes required.

D: All parachutes shall be opened during inspection.

E: The manufacturer's recommendations for LSR use shall be followed regarding parachute size, mounting, etc.

F: Improper parachute performance or vehicle handling problems due to parachute performance shall require re-inspection.

3.N PARACHUTE RELEASE SYSTEM:

Non-manual parachute release systems must also have a manual backup.

3.O FLYWHEELS, FLYWHEEL SHIELDS and BELL HOUSINGS:

All cars over 135 MPH, including rear engine cars, with non-automatic transmissions, shall comply as follows:

A: Flywheels: No cast iron/cast aluminum flywheels shall be permitted.

B: Flywheel Shields: Flywheel shields shall be SFI specification 6.1, 6.2 or 6.3 depending on the application.

C: On cars where no aftermarket flywheel shield is available, and on smaller cars with limited space to install either SFI specification flywheel shield, a SFI specification 4.1 flywheel blanket (shield) may be used or a shield, made from 1/4 in. thick steel, providing 360 degree coverage and retention of clutch and flywheel parts may be used.

D: Bell Housings: Cars utilizing bell housing engine mounts only (Corvaair, VW, etc.) must provide some additional method of parts retention in the car.

3.P EXHAUST SYSTEM:

Systems shall be constructed in such a way that exhaust is directed away from the driver, fuel tanks, tires, and course. Individual stacks shall be connected by welding or other means near the free end.

3.Q FIRE EXTINGUISHING SYSTEMS: (LTA & ECTA ONLY)

A: Under 150 MPH – Not required.

B: 150 - 175 MPH - 5 lbs. Driver area only as a minimum. Driver control.

C: 175+ MPH - 5 lbs. Driver area as a minimum. Driver control.

5 lbs. Engine compartment as a minimum. Driver control.

D: Approved Agents – Driver area:

Halon 1301, Halon 1211, DuPont FE36, AFFF systems including Cold Fire 302, Firefox Gem Foam or Halon replacement certified for confined spaces.

E: Approved Agents – Engine Compartment: All above and CO2.

F: The installation shall be in accord with the manufacturer recommendations.

G: All agent lines and nozzles must be metal and securely mounted.

H: Valves shall be designed to remain open on actuation.

I: Only Halon or Halon replacement may be used in the driver's compartment.

J: Engine area installation must be follow manufactures recommendation.

K: The discharge rate shall be designed to allow sufficient protection for the time it shall take the car to stop from speed.

L: Current inspection/filling certification (no more than 24 months old) for each agent bottle shall be visible.

3.R COOLING SYSTEM:

All liquid cooling systems utilizing non-braided circulation lines shall have metal clamps. The use of plastic tubing or flammable coolants are not allowed.

3.S DRIVE LINES:

Open drive lines in the driver's compartment shall have a protective covering. In all cars with drive shafts, see Section 4.II, there shall be a 360 deg. metal sling (at least ¼ in. x 1 in.) mounted in the front 25% of the drive shaft.

Overrunning clutches (freewheeling) in drivelines are permissible. All traction bars and trailing links shall have a metal sling near the front attaching point of 1/4" min diameter. If the rear wishbones are split and attached to the frame rails to act as traction bars, a 1/4" min metal sling is required.

3.T FRONT END AND SUSPENSION:

All front end and suspension fasteners shall be aircraft type "self-locking" nuts or have wire or keys appropriately placed. All spherical ends (e.g., Heim joints) used in suspension systems shall have washers with a larger OD than the joint (solid type Heim joints are required). Steering stops shall be installed to prevent wheel "flop over" and the tires contact with components.

3.U WINDOWS AND WINDSHIELDS:

All non-stock windows and windshields shall be made of shatter resistant plastic, and shall provide 120 degrees of vision forward. The original roll up window hole may be closed in replacing the frameless glass window with polycarbonate. On open body cars, a windshield is recommended. In all classes where a headrest fairing is permitted, the windshield may sweep around the driver's head and connect to the fairing.

On front and rear windows, metal retaining tabs are required over 175 MPH.

T-tops or moon roofs must have the panels retained with metal tabs or straps.

3.V HOODS:

Hoods are required in all categories (except Special Construction Category). Production hood latches are not sufficient unless the hood opens from the rear. Early type hood hold-downs (spring type) are inadequate.

3.W BRAKES:

Adequate brakes are required. Brake controls shall be within the driver's reach while in the driving position. No front wheel brakes only systems allowed.

3.X BLOWER RESTRAINT SYSTEM:

SFI type blower restraints shall be used on all vehicles using positive displacement blowers. Vehicles where the driver's body is within the rotational plane of the blower shall have containment via an SFI type restraint bag.

3.Y OIL SYSTEM:

Engine oil system must have filters safety wired to ensure retention via integral stud or bung or by wrapping the filter with a hose clamp and wiring.

SECTION 4 DEFINITIONS

The following is a list of terms and meanings used by the LTA.

4.A AIR DUCT:

Aerodynamic pressure relief systems in which air is ducted from one point to another. Cucts shall not extend past exterior bodywork and shall not eliminate a prominent feature. Air ducts shall originate and exit in the rear 50% of the vehicle body and shall not be directed to or away from wheel wells.

4.B AIR INTAKES:

Ducted airflow devices, which are meant to provide combustion air to the engine. Air intakes shall not originate below the original stock location and, on rear engine cars, the air intake must originate in the rear 50% of the body. Air intakes protruding from the front (non-OEM) must not exceed 48" sq. of frontal area, extend more than 12" and must not taper, except where forward streamlining is allowed. Protruding carburetors must be covered with a shield.

4.C AIR VENTS:

Aerodynamic pressure relief systems in which no air ducting is utilized. Louvers and tail light removal fall under this definition.

4.D AUTOMOBILE:

A vehicle propelled by its own means. Steering must be assured by at least 2 front wheels. One pair of wheels shall be on the same transverse centerline.

4.E AUTOMOTIVE PRODUCTION:

Any component which is offered for sale by a recognized automotive manufacturer to the general public as original equipment or accessory to the same is considered automotive production. A production rate of at least 500 vehicles of the same model and year for sale to the general public is considered to meet the requirement of a production automobile.

4.F BALLAST:

Material added to the vehicle for the purpose of additional weight only.

4.G BELLY PAN:

A skin used to cover the undercarriage of a vehicle. It must cover at least 51% of the undercarriage of the vehicle to be considered a belly pan.

4.H BOBBING:

The removal of material from a body component in such a fashion as to alter the original shape at either the top or bottom.

4.I CHOPPING:

The removal of metal from a body component in such a fashion as to reduce the overall height of the component without changing the original shape at either the top or bottom.

4.I.1 CHANNELING:

The lowering of the body over the frame rails.

4.K CONTOUR:

Contour is the configuration of the external sheet metal and windows. All body panels and windows shall be mounted in their original relationship as manufactured unless otherwise allowed.

4.L COVERED WHEEL:

For classification purposes, a wheel shall be considered covered if 120 degrees of the tread circumference is shielded from the air stream by the covering.

4.N ENGINE SWAP:

An engine swap is defined as when an engine from an engine design family that was not available as a factory or dealer installed option for a given vehicle year is used. ELECTRIC CONVERSION IS CONSIDERED AN ENGINE SWAP.

An engine design family is engines which have the same bore centers, crank shaft supports, deck height, cam location, head mounting, bell housing and engine mount patterns, etc. All OEM parts must fit without modification.

4.O FIREWALL: (NON-PRODUCTION)

A metal barrier between the engine and driver compartment, see Section 3.F.

4.P FLOORBOARDS:

Floorboards are defined as paneling in the lower portion of the car exclusive of the engine compartment. Floorboards shall be mounted above the frame or in the stock location for the body style and year of the vehicle. Floorboards shall be inside or over suspension and drive line components, well fitted and securely attached with all holes sealed.

4.Q GASOLINE:

A liquid that does not contain nitrogen bearing compounds, nor propylene oxide, ethylene oxide, and no more than 10% methanol.

4.R HOOD SCOOPS:

A hood scoop is a functional air intake device. No forward facing scoop can extend forward of the leading edge of the hood, be more than 11" above the surface of the hood at the centerline or extend past the trailing edge of the hood more than 11" at the centerline. Clearance between scoop and windshield must be a minimum 1/2". On rear engine cars the scoop shall not extend more than 11 in. above the roof and no further forward than the front edge of the back window.

Rearward facing scoops may extend past the trail edge of the hood but the rear must be open and clearance between scoop and the windshield must be 2" with no sealing.

4.U LIMB RESTRAINT:

A system capable of containing the driver's limbs within the roll structure.

4.V OPEN CAR:

Any car, which may be entered and exited without net or panel movement.

4.W OPEN WHEEL:

A wheel configuration in which no portion of the car's bodywork intrudes upon the inside plane of the tire.

4.X ROOF RAILS:

A metal angle, perpendicular to the roof, and between 1/2" and 3/4" high. Attached parallel from the front to the rear on each side, as close to the edge as practical May extend to the base of the windshield and rear windows.

4.Y SECTIONED:

The removal of a given horizontal width of a body to achieve a lower height.

4.Z SECONDARY FLOORING:

Metal sheeting in the driver's compartment for the purpose of retaining the driver and appendages in the event of step pan or belly pan tear away. Not required in cars with floorboards in the cockpit.

4.AA SET BACK:

The feature of a car which is represented by the formula D/WB where D is the distance measured from the front spindle centerline to the front-most spark plug hole or centerline of the front most cylinder and WB is the wheelbase.

17

4.BB WINDSHIELD POST MOUNTING SUPPORT:

An upright bar, post or support structure to which the windshield posts are bolted, i.e., 1928-1931 and Ford roadsters have this piece.

4.CC STREAMLINING:

Any device which has the apparent purpose of directing, limiting, or controlling air flow around or within the car and was not a part of the original body shall be considered as streamlining.

Removal of certain devices may also be considered streamlining.

4.CC.1 AIR DAMS and SPLITTERS:

OEM or fabricated devices installed below the front bumper used to inhibit and direct airflow from under the vehicle. An air dam may be attached to the leading edge of the bumper and project 1/4" forward of the original contour of the leading edge of the front bumper when viewed from above. Splitters are allowed under the same contours requirements. Bodies may not be cut away to accommodate air dams or splitters.

4.CC.2 Axle Fairing:

Streamlining devices attached to the axle to direct airflow.

4.CC.3 Belly Pan:

A skin of material used to cover the undercarriage of a vehicle.

4.CC.4 Headrest Fairing:

Bodywork, on an open car (Sec 4.V) which extends rearward for the purpose of preventing wind buffeting of the driver. The fairing shall not be wider than the roll cage at any point, nor extend past the rearmost part of the body.

4.CC.5 Skirts:

Streamlining devices added to the lower portion of the body for the purpose of controlling airflow under the body. The skirt shall be in a single plane, mounted to the bottom of the body but cannot modify the contour of the body. The skirts may extend from the centerline of the front axle to a vertical plane at the rearmost point of the original bodyline.

4.CC.6 Spoiler:

A device on the upper portion of the body for the purpose of spoiling lift. It shall be mounted in the rear portion of the body behind the rear axle centerline. Two different designs can be used but not combined. See figures 11 and 12.

DESIGN ONE: The spoiler must have a continuous surface no wider than the outside edge of the rear tires. The maximum chord measured on the top surface at the center of the car can be 10". A 1 in. tab or hinge may be added to the leading edge of the spoiler for the mounting purposes only. A spill plate on each side of the spoiler is allowed and must be mounted vertically and parallel. It can extend no further forward than to the rear axle centerline. Spill plates are allowed to be no more than 8 in. above and below the forward mounted position of the spoiler when the spoiler is parallel with the ground and extend no more than 2 in. max past the end of the spoiler. No appendages or holes are allowed. Gurney flaps are allowed but cannot extend above or behind the spill plates.

DESIGN TWO: The spoiler must have a single continuous surface with no side plates. Maximum spoiler chord measured on the top surface is 10 in. from the trailing edge of the body. A 1 in. tab can be added to the lead edge of the spoiler for mounting purposes only. The ends of the spoiler must follow the contour of the body and shall not extend beyond the outside edges of the body at any point. When laid flat the width of the spoiler can be a no more than 16 in. wider than the outside plane of the rear tires. No other aero devices or Gurney Flap are allowed with this design.

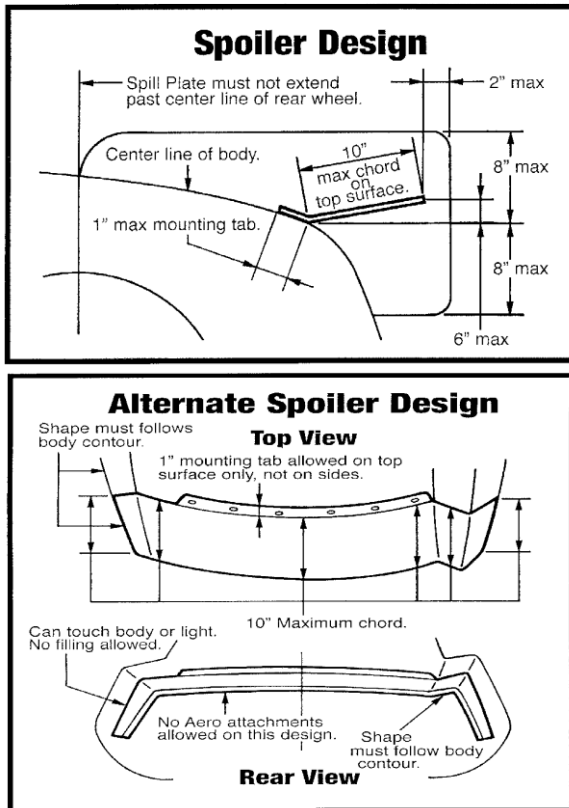

4.CC.7 Trip Fences:

A device in the upper forward part of the body to tripping the laminar layer.

4.CC.8 Vortex Generators:

Sharp edged devices placed on the body to create flow vortices.

4.CC.9 Wings:

Aerodynamic devices intended to provide down force, which are allowed ONLY on Streamliners, Lakesters, Modified Roadsters, Competition Coupes and Production bodies which had the wing as OEM or an option.

4.CC.10 Parachute Pack Mounts:

A parachute pack mounting plate must not extend more than 1" past the edge of the Parachute bag on all sides. The maximum length on all sides supporting the mounting plate shall be 6". If two chutes bags are mounted side by side on the same plate the max space allowed between them is 4". No more than two chutes can be mounted on one mounting

plate. If the pack mount/mounts have to be more than 6" of the body a tube structure must support the mounting plate/plates.

4.CC.11 Parachute Mounting Tubes:

Parachute mounting tubes may extend no further than 6" behind the rearmost part of the original body and must not be faired into the body. The maximum length of any side of a tube extending from the body is 12".

4.CC.12 Strake:

Strake is an aerodynamic device located under the rear portion of the vehicle at the rear of the vehicle that is intended to direct air flow. The strake may extend no further than the trailing edge of the body, must be perpendicular to the ground and parallel to the center line of the vehicle. The strake may be located no further out than the inner plane of the rear tires and may extend no further forward than the firewall or body cowl line, whichever is further forward. Strakes that are OEM are allowed.

4.DD STREET EQUIPMENT:

That equipment required for legal street operation in most states.

4.EE STEP PAN:

A step pan may enclose the area from the aft-most portion of the firewall to a line 10 in. forward of the rear axle centerline and shall not be lower than the frame at any point plus the thickness of the material used.

The step pan shall be flat, parallel to the ground (side to side) and no wider than the frame rails. A box may be constructed to enclose the portion of the transmission which protrudes through the step pan. The box must be rectangular in design and untapered in any way, flat on the bottom, cover only the exposed portion of the transmission with a maximum clearance from the transmission of 1". Chassis cross members are not considered as part of the frame for purposes of this rule. The transition at the rear of the step pan to the floorboard shall occur at a 45 degree or steeper angle.

4.FF SUPERCHARGED:

Blown (supercharged) is an artificially aspirated engine with a mechanically driven supercharger or exhaust driven turbocharger powered by the engine.

To run up in class, normally aspirated engines may be classified as Blown.

4.HH WHEELBASE:

All vehicles must have at least two parallel axles. The wheelbase is the distance measured from the centerline of the rear axle to the transverse center line of the front spindles. Streamliners are exempt from this rule.

4.II DRIVESHAFT:

A driveshaft is defined as the connection from the engine or transmission to the rear drive unit in a conventional front engine/rear drive configuration.

4.JJ BUMPER:

A bumper is a metal device bolted to the chassis to provide collision protection. Bumper are considered to be part of the body and shall not be removed or altered if not allowed by class rules. In streamlining, fascia ends once above or below the impact absorbing region of the metal bumper.

4.KK OEM BODY KIT:

Body kits produced by an automobile manufacturer for a specific year vehicle must be used as a complete package. 500 kits for the same model were/are required to be for sale to the general public meets the production requirements. Mixing and matching pieces from different years or not using the complete kit shall be considered streamlining.

SECTION 5 CAR CLASSES

The car classes are divided into 10 general Categories: Street, Production, Roadster, Modified, Classic, Vintage, Truck, and Special Construction, Electric, Supercar.

5.A STREET CATEGORY



This category is intended for street driven vehicles. Cars, Street Rods, Pick-up Trucks and Sports Cars are included. In keeping with the intent of the class, all vehicles must be licensed/tagged and insured. Fiberglass reproduction or phantom bodies are acceptable as long as the vehicle is street legal.

5.A.1 Time Only (T/O)

Time only is reserved for vehicles that meet the safety requirements of Section 3 for the speed they intend to run but

- A: do not fit into a class, or
- B: wish to run for testing only and not for records.

5.A.3 Super Street - /GSS, /FSS, /BGSS, /BFSS

- A: All applicable rules in Section 3 must be met for your intended speed.
- B: Multiple Carburetion, Fuel Injection and Superchargers / Turbochargers allowed In Super Street.
- C: Nitrous Oxide is the only additional fuel additive allowed in the fuel class.
- D: Alcohol and Nitromethane are NOT permitted.
- E: No items are allowed that would make any vehicle illegal for street use.

Engine classes allowed are: ALL ICE and Electric Engine Classes.



20

5.A.4 Real Street - /GRS, /FRS

- A: All applicable rules in Section 3 must be met for your intended speed.
- B: Real Street vehicles are limited to single 4-bbl carburetor or any combination originally offered and installed by the factory.
- C: No fuel injection and no supercharging allowed.
- D: Alcohol and Nitromethane are NOT permitted.
- E: No items are allowed that would make any vehicle illegal for street use.

Engine classes allowed are: ALL ICE engines with an N/A single 4-barrell

5.B PRODUCTION CATEGORY

This category is intended to represent typical transportation vehicles which may be purchased from an automobile dealer. A generic requirement for this category is the car shall have been originally produced with seating for four or more people, i.e. adults or children. If sold with 2 or 4 seats configurations (including jump seats), the car may be classified as a Coupe or Sedan. In keeping with this intent, the cars are aerodynamically "stone stock" with no body parts allowed which were not OEM or factory options.

THE MINIMUM REQUIREMENT FOR A VEHICLE WITHIN THE YEAR RANGE OF 1928- 1981 TO COMPETE IN PRODUCTION CATEGORIES MUST BE THE USE OF A NON-O.E.M. EFI SYSTEM.

The engine used must have been available in the model of vehicle used as purchased from ANY automobile dealer.

The following items shall be retained in stock location and of the same year as the body: frame, fenders, hood, grille, drip rails (must not be filled), windows, door handles, window trim, headlights (high and low beam), tail lights, parking lights, stop lights, radiator, front and rear bumpers and horn. The stock gas tank must be fitted but need not be used.

Racing seats shall be used per Section 3.D.1. The original side panel upholstery, both front and rear, must remain or be replaced with an aluminum equivalent. A stock or fabricated full width dashboard is mandatory. Carpet, headliner, minor chrome trim and emblems may be removed.

A different displacement size of the same design engine may be used provided it does not constitute an engine swap. Any transmission, non-quick change rear end, and an on-board starter shall be used so long as the original running gear design is retained.

Cylinder heads are limited to original number of valves and port configuration.

Vehicles in this category that exceed 200 MPH, or if the existing record is over 200 MPH, shall have roof rails, see Section 4.X.

All closed vehicles that would qualify as a V4 or V4F Production coupe or sedan shall compete in the V4 or V4F Gas Coupe class.

Vehicles using a hybrid power source, such as a gasoline/ battery pack, shall compete in the equivalent cubic inch class of the gasoline engine. The battery pack MUST be the stock unit as sold with the vehicle model used.

5.B.1 Production Coupe And Sedan - /GPRO, /FPRO

American coupes and sedans 1928 to current year, foreign coupes and sedans 1949 to current year, or 1928-1981 American coupes and sedans that do not meet the requirements for Classic Category.

The vehicle shall be unaltered in height, width or contour.

A replacement radiator of the same height and width and mounted in the original location as OEM may be used. Blocking air flow through the radiator is not allowed.

The following modifications are allowed:

- A: Headers.
- B: Hood scoop (Section 4.R).
- C: Wheel openings may be radiused for tire clearance.
- D: Passenger and rear seat may be removed.
- E: Air dams and air spoilers identical to OEM or factory optional equipment.

The following are NOT allowed:

- A: Streamlining, (Section 4.CC and subsections).
- B: Air Ducts (Section 4.A) or Air Vents (Section 4.C).
- C: Chopping (Section 4.I) or Channeling (Section 4.I.1).

Engine classes allowed are: ALL ICE and Electric Engine Classes.

21

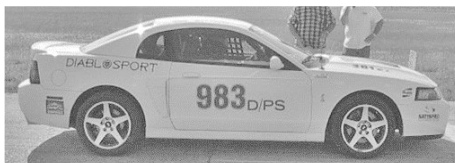

5.B.2 Production-Supercharged - /PS

This class is intended for American and foreign coupes and sedans that meet the requirement of the Production Coupe and Sedan Class /PRO that are equipped with factory supercharger systems. The vehicle shall be as originally equipped and configured.

Engine classes allowed are : ALL Engine Classes - Blown & Turbo Charged



5.B.3 Grand Touring - /GT, /BGT /FGT, /BFGT

This class is limited to 2-seat production sports cars like the Corvette, Honda S-2000 or Fiero as well as limited production cars like the Factory Five Cobra manufactured by a recognized automobile.

Independent rear suspension may be replaced with non-quick change rear.

The following modifications are REQUIRED:

- A: All vehicles must use a seat designed for racing, see Section 3.D.1.
- B: The original side panel upholstery or equivalent must remain.

The following modifications are ALLOWED:

- A: Wheel openings may be radiused for tire clearance.
- B: The generator/alternator may be removed.
- C: Exhaust system capable of being closed off may be used (no stacks).
- D: Air dams and spoilers identical to OEM of factory optional equipment.
- E: Minor chrome trim and emblems may be removed.
- F: An OEM Air Intake (Section 4.B) may be used.
- G: The stock windshield may not be removed or lowered.
- H: Engine swaps used in an automobile produced by the same manufacturer.

The following modifications are NOT allowed:

- A: Streamlining (Section 4.CC and subsections).
- B: Air Ducts (Section 4.A), Air Vents (Section 4.C), or headlight air intakes.
- C: Chopping (Section 4.I) or Channeling (Section 4.I.1).

Engine classes allowed are: ALL ICE and Electric Engine Classes.

5.C ROADSTER CATEGORY



22

This category is specifically intended for the lovers of American Roadsters. Cars shall have an American production automobile roadster body produced between 1923 and 1938 or an exact aluminum or fiberglass replica. No modification is allowed to the body proper from the stock firewall location back and the window down, and only limited modifications are allowed to the hood and top or as explicitly allowed in the class rules.

Firewalls may be altered, moved or replaced entirely.

No fenders are allowed on MODIFIED, FUEL or GAS Roadsters.

TURBOCHARGERS ARE NOT ALLOWED ON VINTAGE CLASS ENGINES.

The minimum tread dimensions for all Vintage Category vehicles are 44 in. front and 50 in. rear. Rear axles may be narrowed as long as no part of the tires extends within the body shell. Modified Roadsters are exempt from the front tread requirement. The minimum wheel diameter for all Roadsters is 14".



5.C.1 Street Roadster - /GSTR, /FSTR, /BGSTR, /BFSTR

In addition to the general category requirements the body shall not be altered in height, width or contour, and all stock panels that are an integral part of the body, i.e. welded on or formed shall be retained. On roadsters with non-removable windshield posts, the windshield structure may be cut off 1 in. above the lowest outer edge of the windshield frame.

Hood length, as determined by the year of the BODY, may be increased a maximum of 3 in. as measured along the top centerline of the hood and front cross members may be moved to correspond. Hood side panels if used or doors are not required. Hood side panels may be trimmed away for clearance of structural chassis or engine components. Bubbles or bulges

may cover modifications made to the hood side panel to clear components so long as they do not violate the applicable portions of streamlining, Section 4.C.C.

Rear fenders are required. The fenders may be bobbed to the bottom of the body, but may not be relocated, narrowed, or widened. The outer edge of a bobbed fender cannot be cut on a radius greater than the bottom of the original fender.

A maximum of 15% engine set back is permitted. A radiator/grille shell may be sectioned or bobbed but not less than 530 sq. in. in frontal area. The width may not be altered. If switched, the grille shell must be of the same manufacturer as the body. The radiator must fill the shell opening. The grille shell insert must remain open as in the original configuration and be stock style or removed completely.

Only cylindrical tanks are allowed in front of the grille. The tank shall be mounted horizontally between and above the frame rails. The maximum allowable dimensions for the tank are: 10 in. OD, 19 in. long, mounted a maximum of 2 in. from the leading edge of the grille.

Any frame may be used which is fabricated of round, square, or rectangular steel tubing, not less than 2 in. x .120 in. or channel not less than 4 in. x .120 in. Any type rear end may be used, and widening of rear tread to allow tires protrude beyond the fenders is permitted as long as 50% of the tire width is still covered by the fender.

The driver shall sit in the stock location. The body may be channeled to the bottom of the frame. Flooring in the car shall be stock, or above the top lip of the top frame rail, and comply with the definition contained in Section 4.P.

A rigid tonneau cover is allowed.

The following items are required: a horn, at least one tail/stop light, a transmission and two headlights facing forward in stock orientation. Headlight lenses shall be at least 5 in. in diameter. Both lights shall be mounted outside the vertical edges of the grille shell and between 18 in. and 24 in. from the ground, measured to the centerline of the headlight.

The following items are optional: bumpers, upholstery, generator, parking brake, license plate, front fenders, running boards or windshield. Louvers in the rear deck lid are allowed as long as they are sealed on the inside. Hood scoop allowed. Headers may be used, but shall terminate in a common collector, a minimum of 6" long beyond the end of the header tube.

The following are not allowed. Sectioning, Step Pan, and Streamlining.

Engine classes allowed are: ALL ICE and Electric Engine Classes.



5.C.2 Gas/Fuel Roadster -/GR, /FR, /BGR, /BFR

In addition to the general category requirements any type frame may be used and the body may be channeled to the bottom of the lower frame rail. Engines may be set back 25% of the wheelbase. Driver location is optional as long as the driver's entire body is between the firewall and the rear axle centerline.

The rear axle centerline may not be moved more than four inches aft from the stock position and rear tires may not extend more than 1 in. beyond the rear most part of the body proper.

The configuration of the bodywork between the original windshield line and the grille shell is optional, as long as the overall length of the car, from the front of the grille shell to the rear of the body, with any grille shell, is no greater than 143 in. for all roadsters except 1933/34 roadsters, which are allowed 152 in. All other roadsters whose stock production length is longer than 143 in. shall be allowed their stock production length.

Grille shells must have a minimum of 530 sq. in. of frontal area ('28 Ford) and must be mounted in the same vertical position as the original shell. The grille shell shall be measured at the widest point at the original shell and hood parting line and the width may not be altered but may be sectioned or bobbed. The height of the grille shell may be no higher than the cowl of the body as constructed. Grille shells of a design manufactured after 1932 may not be used on 1932 or earlier bodies.

The body at the original windshield line may be re-contoured to a flatter configuration, so long as the body contour is not lower than the top of the doors and the distance between the bottom of the frame and body contour, measured at the original windshield line, is not less than 28- 1/4 in.

The following alterations are allowed:

A: Door hinges, windshield posts, filler caps, and brackets may be removed.

B: Flat panels may cover grille openings.

C: Step pans.

D: A flat panel may be located behind the grille shell and ahead of the vertical projection of the leading edge of the engine block. This panel must not be lower than the frame at any point plus the thickness of the material used.

E: Streamlining, Air Ducts, Air Intakes /Vents, Hood Scoop, Headrest Fairing.

The following alterations are not allowed:

A: Belly pans or any other horizontal paneling not fitting the definition of floorboard is specifically forbidden.

B: Streamlining, as defined in Section 4.CC is NOT allowed.

C: Tanks of any kind in front of the grille shell are specifically prohibited.

Minimum Wheelbase Requirements: NONE

Engine classes allowed are: ALL ICE and Electric Engine Classes.

24



5.C.3 Modified Roadster - /GMR, /FMR, /BGMR, /BFMR

In addition to the general category requirements, any type of frame may be used, and the engine may be set back 50% of the wheelbase.

The combined body area covered or altered by the headrest fairing, all parachute fairings, and any other allowed body protuberances or displacements, from the original cockpit opening to the rear of the car cannot exceed 65%, as measured in a horizontal plane from the top view.

The driver's seat may be at any location between the firewall and the rear axle centerline. The body may be cut out to move the driver as far back as possible.

The body at the original windshield line may be re-contoured to a flatter configuration, so long as the body top contour is not lower than the top of the doors as measured at the front edge of the doors.

Streamlining ahead of and including the cowl and channeling is permitted. Air intakes, air vents and the following as defined in Section 4.CC are allowed: Splitters, Axle Fairing, Belly Pan, Headrest Fairing, Skirts, Strakes, and Wings.

Headrest and parachute pack fairing are allowed as long as the fairing is no larger than the headrest or parachute pack and does not extend past the rear of the body shell. Push bars shall not be solid or offer any aero advantage.

Wings are allowed. The wing width, including side plates, shall not be wider than the inner vertical plane of the rear tires. The maximum allowable height of the highest part of the wing shall not exceed 65 in. from the ground. The rear of the wing, including side plates, may not be set back more than 18 in. behind the rear of the body. The total wing size (measured by the fore to aft dimension times the side to side dimension, on the top surface) shall not

exceed 1152 sq. in. The lowest portion of the wing shall be at least 12 in. above the roll cage structure. Multiple element wings, spoilers and four wheel drive systems are NOT allowed. Splitters may not extend beyond the inner plane of the rear tires nor beyond the aft most portion of the body.

Stock wheel wells may be filled, but the rear axle shall not be narrowed to the point that the inner vertical plane of the rear tires is narrower than the original inner fender well. No alterations to the turtle deck are allowed.

No fairing or special covering of the wheels and tires is permitted.

Maximum wheelbase is 190". Allowed min tread widths are 50" rear, 38" front.

Minimum Wheelbase Requirements: NONE

Engine classes allowed are: ALL ICE and Electric Engine Classes.



5.C.4 Rear Engine Mod Roadster –/GRMR, /FRMR, /BGRMR, /BFRMR

This class shall meet the requirement of the Modified Roadster Class and the additional requirements below:

The driver's seat must be entirely in front of the engine.

The entire engine must be forward of the centerline of the rear axle.

A rigid tonneau cover and headrest fairing are allowed as long as they do not violate the definition of an open car.

Minimum wheelbase is 140 in. and maximum wheel base is 190 in. Allowable minimum tread widths are 50 in. rear and 38 in. front. Allowable body width across the bottom of the doors must meet the dimension as originally produced by the manufacturer. The entrant must provide this dimension.

Engine classes allowed are: ALL ICE and Engine Classes.

25

5.D MODIFIED CATEGORY

American coupes and sedans 1928 to current year, foreign coupes and sedans 1949 to current year and 1928-1981 American coupes and sedans that do not meet the requirements for Classic Category. This category encompasses American and foreign coupes and sedans unaltered in height, width or contour. The vehicle has been modified to such an extent that it no longer fits into the Production Category. A generic requirement for this category is the car shall have been originally produced with seating for four or more people, i.e. adults or children. If sold with 2 or 4 seats configurations (including jump seats), the car may be classified as a Coupe or Sedan.

THE MINIMUM REQUIREMENT FOR A VEHICLE WITHIN THE YEAR RANGE OF 1928- 1981 TO COMPETE IN THE MODIFIED CATEGORIES MUST BE THE USE OF A NON-O.E.M. EFI SYSTEM.

Coupes and sedans produced from 1949 to the current model year, and not meeting the criteria of the Classic Category, must compete in the Modified Category classes.

Within Modified, the amount of modification determines class. For example, a Gas Coupe is basically a Production car with an engine swap, an Altered is a Gas Coupe with headlights and grille covered and the engine set back, a Competition Coupe is an Altered with the nose lengthened and streamlined.

The driver shall sit completely ahead of the rear axle, inside the body, and behind the engine, except in rear engines using the original engine location.

In classes where the removal of rear view mirrors is allowed the OEM fender or door shape must be retained.

Front air dams and splitters are permitted in the Modified Category.

5.D.1 Competition Coupe & Sedan - /GCC, /FCC, /BGCC, /BFCC

This class encompasses production coupe or sedan bodies unaltered in width or contour and shall comply with the general rules of the category. Streamlining ahead of and including the cowl, channeling, belly pan, skirts and spoilers, as defined in Section 4.CC. is permitted.

One of the following modifications MUST be done to be in this class:

- A: Top chopped.
- B: A full belly pan.
- C: The body from the cowl forward lengthened a minimum of 12".
- D: The engine set back between of 25% and 50% of the wheelbase.

Other than top chopping, no modification to the body allowed. The front and rear chop shall be equal. Minimum vertical windshield height is 5 in. Window openings may be covered by flat plates on the outside or left open. Drip rails may be removed or filled. Driver shall sit ahead of the rear axle and behind the engine, except in rear engine cars using the original engine location.

Wings are allowed per Modified Roadster.

NOTE: Entrants electing to use a pre-1949 body in the Competition Coupe classes need not comply with the seating requirement for four (4) average size adults. The rear inner fender panels may be modified to allow the rear tires to be located within the body.

Engine classes allowed are: ALL ICE and Electric Engine Classes.

26



5.D.2 Altered Coupe - /GALT, /FALT, /BGALT, /BFALT

This class encompasses American and foreign coupe or sedan bodies 1928 to the current year, unaltered in height, width, length or contour. Cars in this class must comply with the General Rules of the Modified Category.

One of the following modifications must be done to be considered in this class:

- A: The addition of a step pan as defined in Section 4.EE.
- B: The engine setback max. of 25% of wheelbase as defined in Sec. 4.AA.
- C: A front wheel drive vehicle converted to rear wheel drive.
- D: Covered headlights and grille as described below.

Any frame may be used as long as the bottom line of the frame is not higher than the outer bottom line of the body between the firewall and the rear wheels. An exception shall be made if the ORIGINAL frame/body relationship is such that the lower bottom line of the frame is above the outer bottom line of the body, that frame/body combination may be used. The frame may not be exposed from the bottom of the body.

The following are allowed:

- A: A 2% maximum body stretch in the cowl area, in front of the firewall. This does not apply to Vintage class.
- B: An engine swap as defined in Section 4.N is permitted.
- C: Bumpers may be narrowed or faired.
- D: Grilles and front lights may be removed and the opening created may be filled or covered. The filled or covered area may be flush with the adjacent body so long as the basic shape and contour of the vehicle is not changed. Engine intake air may be ducted from these openings.
- E: Drip rails may be removed.
- F: Taped or filled body, door or window seams are allowed from the firewall back. Windows shall be mounted in the stock fashion or fastened to the inside of the window openings.

- G: A non-stock spoiler is permitted as defined in section 4.CC.6.
- H: Pre-1949 bodies may be chopped. The chop shall be equal front to rear and must retain a vertical windshield height of at least 6 in. above the top of the cowl with a maximum horizontal length of 7 in. from the base of the windshield at the center of the car.
- I: After market front ends are allowed that conform to the class guidelines.
- J: Any exhaust that exits anywhere from the body but the top.

The following are not allowed:

- A: Wheel wells may not be filled or covered.
- B: No streamlining, as described in Section 4.CC, unless specified.
- C: Any horizontal paneling which may be construed as a belly pan.
- D: Roof mounted spoilers, other than OEM.

Vehicles in this category that exceed 200 MPH shall have roof rails.

Engine classes allowed are: ALL ICE and Electric Engine Classes.



5.D.3 Gas Coupe And Sedan - /GC, /FC, /BGC, /BFC

This class encompasses American coupe, sedan or convertible bodies 1982 to current; and foreign coupe, sedan or convertible bodies 1928 to current year unaltered in height, width, length or contour.

27

One of the following modifications must be done to be considered in this class: (Any one of which makes the car ineligible for competition in Production class):

- A: Engine swap.
- B: Quick-change rear end.
- C: Non-stock supercharger.

The following items shall be retained in the stock location and of the same year as the body: frame, fenders, hood, grille, drip rails (shall not be filled), windows, door handles, window trim, headlights (high and low beam), tail lights, parking lights, stop lights and bumpers. A replacement radiator of the same height and width and mounted in the original location as OEM may be used. . The original grill opening shall remain uncovered. An onboard starter capable of starting the engine shall be used.

The following modifications ARE allowed:

- A) The engine set back a maximum of 2% of the wheelbase.
- B) Wheel openings radiused for tire clearance.
- C) The generator/alternator, horn and stock gas tank removed.
- D) Air dams that do not cover the original grille opening. See specifications outlined in Modified Category description.
- E) Air intakes per Section 4.B may be used.
- F) Headers.
- G) Exhaust collectors may exit through the front fenders.
- H) Minor chrome trim and emblems may be removed.
- I) Upholstery and the passenger seat assembly may be removed.

The following modifications are NOT allowed:

- 1) No individual exhaust stacks or exhaust outlets through the doors or hood.
- 2) Front wheel drive cars that have been converted to rear wheel drive.
- 3) Streamlining as described in Section 4.CC unless specified.
- 4) Air vents, headlight air intake, one piece front ends.
- 5) Channeling.
- 6) Blocking air flow through the grill or radiator.
- 7) Taped or filled body, door, or window seams.

Vehicles in this category that exceed 200 MPH shall have roof rails.

Engine classes allowed are: ALL ICE and Electric Engine Classes.



5.D.4 Modified Sports - GMS, /FMS, /BGMS, /BFMS

This class is intended for production sports cars as accepted for GT class, which have been modified to make the vehicle illegal for the /GT.

The following items are required: a starter capable of starting the engine, tail/stop lights, a transmission (either manual or automatic), and a radiator when originally equipped.

- 1) Production GT class cars with an engine swap shall be allowed.
- 2) Any frame may be used, see Section 2.D. Maximum wheelbase is 130".
- 3) Any type of rear end may be used.
- 4) Engine placement is optional, so long as no change is made to the driver's location as originally designed. The driver must be seated behind the engine, except when originally designed for mid/rear engine locations.
- 5) Coupe tops may be chopped and windshields may be lowered or removed.
- 6) Front tread width may be narrowed to a minimum of 27 in.
- 7) Front fenders may be removed at the stock fender location or at a point no further forward than 6 in. from the base of the windshield, measured at the centerline of the vehicle.
- 8) Streamlining ahead of and including the cowl, channeling, belly pan and skirts is allowed.
- 9) Wings offered as an OEM or factory option may be used.
- 10) Spoilers as defined in Section 4.CC.6 are allowed.
- 11) Removal of minor trim and bumpers is allowed as long as the body is not altered in length, width or contour. Drip rails may be removed or filled.
- 12) Limited production (a minimum of 50 examples produced) sports car bodies, which may be placed on any frame, shall be permitted.

The following modifications are NOT allowed:

- 1) Air Vents (Section 4.C).
- 2) Headrest Fairing (Section 4.CC.4) which extends past the rear of the body.

Engine classes allowed are: ALL ICE and Electric Engine Classes.



5.D.5 CIRCLE TRACK - /GCT, /BGCT, /FCT, /BFCT

This class is for all circle track and road race cars, dirt or pavement

Cars must be rear wheel drive. The driver shall sit entirely behind the engine and in front of the rear axle. The frame may be of any construction meeting safety rules, however all wheels must be sprung. Cars in this class must have a fully functioning radiator mounted in front of the engine. Spoilers, air dams and hood scoops are acceptable. Wings and nerf bars that give aerodynamic aid are not permitted. Door windows are not allowed on cars that have non-functional doors. Gasoline and Alcohol are accepted fuels for this class. Nitrous Oxide and Nitromethane are not acceptable.

Minimum wheel base requirements: NONE

Engine classes allowed are: ALL ICE and Electric Engine Classes.



5.E CLASSIC CATEGORY

Coupes and sedans produced from 1949 to the current model year, not meeting the criteria of the Classic Category, must compete in the Modified Category classes.

The classes within this category are intended for coupes and sedans from the "Golden Era" of automobile production. This category encompasses American and Foreign coupes and sedans produced between 1928.

Entries must be unaltered in height, width, and contour. The vehicle must have been originally produced with suitable seating for four adults. For reasons of historical authenticity, certain electronic engine technologies are not allowed.

Class Distinctions:

- 1) Classic Category are the equivalent of **Production and Modified** categories with body modifications as allowed in those categories.
- 2) American coupes and sedans in the year range of 1928-1948 using non-vintage engines may compete with the fenders and running boards removed in the Classic Altered classes.
- 3) Within the Classic Category pre-1949 bodies may have a 3 in. beauty chop.
- 4) Foreign coupes and sedans are limited to maximum 'F' engine size.



29

The following modifications ARE allowed:

- 1) One distributor or magneto (one ignition system only).
- 2) Capacitive discharge type ignition systems with rev limiter.
- 3) Unaltered original Sensor controlled ignitions are allowed.
- 4) Carburetors or mechanical fuel injection, or OEM EFI.
- 5) Electronic or mechanical gauges and data recorders are allowed.

The following modifications are NOT allowed:

- 1) Non-OEM Electronic Fuel Injection, (EFI).
- 2) Sensor controlled engine management systems with feedback loop.

Body Classes: /CPRO, /BCPRO /CBFALT, /CFALT, /CBGALT, /CGALT, /CBGC, /CGC

Engine classes allowed are: ALL ICE Engine.

5.F VINTAGE CATEGORY

This category is specifically intended for the lovers of antique iron. Although fiberglass and aluminum bodies are allowed, the body shall be an exact replica of an American production automobile body car except for the Vintage Oval Track class. No modification is allowed to the body proper from the stock firewall location back and the window down, and only limited modifications are allowed to the hood and top.

This category is organized into two groups: VINTAGE COUPES AND SEDANS, which are special vintage classes for the Modified Category; and VINTAGE OVAL TRACK, a special class for oval track and speedway vehicles with pre-1948 designed engines.

Only automobile bodies produced by an American manufacturer prior to 1948 or exact replicas of such bodies are allowed. Tops may be chopped, but no other alteration to the contour or size of the body shell is allowed except as specifically allowed in the class rules. Wheel wells may be filled but not deepened. Rear axles may be narrowed as long as no part of the tires extends within the body shell.

TURBOCHARGERS ARE NOT ALLOWED.

The minimum tread dimensions for all Vintage Category vehicles are 44 in. front and 50 in. rear. Modified Roadsters are exempt from the front tread requirement. The minimum wheel diameter for all Vintage Category vehicles with the exception of /VOT is 14 in. No fenders are allowed on MODIFIED, FUEL or GAS Roadsters. Firewalls may be altered, moved or replaced entirely.



5.F.1 VINTAGE COUPE & SEDAN Classes:

One of the following modifications shall be done to be considered in the Vintage Competition Coupe class:

- 1) The top chopped more than 3 in.
- 2) A full belly pan.
- 3) The body from the cowl forward lengthened a minimum of 12 in.
- 4) The engine set back a between 25% and 50% of the wheelbase.

VINTAGE GAS COUPE and SEDAN:

XF/VGC, XO/VGC, XXF/VGC, XXO/VGC, V4/VGC and V4F/VGC

BLOWN VINTAGE GAS COUPE and SEDAN:

XF/BVGC, XO/BVGC, XXF/BVGC, XXO/BVGC, V4/BVGC and V4F/BVGC

VINTAGE GAS COMPETITION COUPE:

VF/VGCC, XO/VGCC, XXF/VGCC, XXO/VGCC, V4/VGCC and V4F/VGCC

VINTAGE FUEL COMPETITION COUPE:

XF/VFCC, XO/VFCC, XXF/VFCC, XXO/VFCC, V4/VFCC and V4F/VFCC

BLOWN VINTAGE GAS COMPETITION COUPE:

XF/BVGCC, XO/BVGCC, XXF/BVGCC, XXO/BVGCC, V4/BVGCC and V4F/BVGCC

BLOWN VINTAGE FUEL COMPETITION COUPE:

XF/BVFCC, XO/BVFCC, XXF/BVFCC, XXO/BVFCC, V4/BVFCC and V4F/BVFCC

VINTAGE GAS ALTERED COUPE:

XF/VGALT, XO/VGALT, XXF/VGALT, XXO/VGALT, V4/VGALT and V4F/VGALT

VINTAGE FUEL ALTERED COUPE:

XF/VFALT, XO/VFALT, XXF/VFALT, XXO/VFALT, V4/VFALT and V4F/VFALT

BLOWN VINTAGE GAS ALTERED COUPE:

XF/BVGALT, XO/BVGALT, XXF/BVGALT, XXO/BVGALT, V4/BVGALT and V4F/BVGALT

BLOWN VINTAGE FUEL ALTERED COUPE:

XF/BVFALT, XO/BVFALT, XXF/BVFALT, XXO/BVFALT, V4/BVFALT and V4F/BVFALT

The rules in these classes are identical to the respective Modified Category classes. In all classes except VGC, fenders and running boards may be removed if attached by bolts. Pre-1949 bodies may have a 3" beauty chop. Pre-1949 shall have radiator shells of the same manufacturer as the body.

Air dams are not permitted in the Vintage Gas Coupe and Sedan classes using vintage engines.

All closed vehicles that would qualify as a V4 or V4F Production Coupe or Sedan shall compete in the V4/V4F Gas Coupe class. All open vehicles that would qualify as V4 or V4F production roadster shall compete in the V4/V4F Street Roadster class.

5.G TRUCK CATEGORY

General Category Requirements:

The body must remain unaltered in height, width and contour, with all stock panels in original relationships with each other.

Pickups with cab mounted gas tanks must have gas tank removed. The tank must be relocated so as to offer no aerodynamic advantage.

Covering beds with tarps or panels is allowed. The cover shall be no higher than the edge of the bed. Aftermarket bed caps are allowed but must not allow any aerodynamic advantage.

Pickups may run with the tailgate raised, lowered or removed. The exhaust shall not exit through the pickup bed floor.



5.G.1 Production Pickup Truck - /PP /BPP (Gas Only)

Pickups in this class are required to comply with all class rules as well as all rules in the Production Category (5.B), Production Class (5.B.1).

Any supercharger and/or production full-time four-wheel drive trucks shall compete in the Modified Pickup class.

Engine classes allowed are: ALL ICE and Electric Engine Classes.



5.G.2 Mid/Mini Production Pickup Truck - /MPP /BMPP

This class is for 1972 and later American and foreign Mid/Mini sized pickup.

Must comply with all rules In Production Pickup /PP.

Engine classes allowed are: ALL ICE and Electric Engine Classes.



5.G.3 Modified Pickup Truck - /MP, /BMP

This class is for 1946 and later American made pickup trucks.

Pickup trucks in this class are required to comply with all class rules as well as all rules in the Modified Category, Gas Coupe class.

Minimum requirements to compete in the Modified Pickup class are at least one of the following:

- A) Engine swap
- B) Quick change rear end
- C) Non-stock supercharger

Production pickups with a supercharger and/or full-time four-wheel drive shall compete in this category and class.

No streamlining as described in Section 4.CC is allowed unless specified.

Engine classes allowed are: ALL ICE and Electric Engine Classes.



5.G.4 Modified Mid/Mini Pickup Truck - /MMP, /BMMP

This class is for 1972 and later American and foreign Mid/Mini sized pickup.

Must comply with all rules In Production Pickup /MP.

Engine classes allowed are: ALL ICE and Electric Engine Classes.

5.G.5 Diesel Truck - /DT

This class is intended for diesel pickup trucks that may be of either American or foreign manufacture. This class is limited to (1) ton vehicles.

Pickup trucks in this class are required to comply with all class rules as well as all rules in the Modified Category, Gas Coupe class.

Engine and driveline swaps are permitted. Flywheel shields are mandatory. Roll bars, if required, must be mounted inside the cab.

Engine classes allowed are: ALL ICE Engine Classes.

5.G.6 Modified Diesel Truck - /MDT

This class is for diesel trucks with modified bodies not otherwise legal for Diesel Truck class. The body may not be altered in height, width or length. Truck frame and running gear must be used.

Trucks weighing over 14,500 lbs. are allowed unlimited engine displacement. Full size trucks are limited to a maximum of 750 cid. Trucks based on Mid/Mini chassis are limited to a maximum of 500 cid. There are NO engine displacement class breaks. All vehicles shall compete against the same record.

Streamlining behind the cab such as elongated bed or similar body work, not to exceed the height of the stock bed is allowed. Class 8 trucks may have any fairing between the wheels and frame covers not to extend above the top of the rear tires or frame rail, whichever is higher. Skid plates must NOT be designed so as to form a belly pan. Streamlining devices are NOT allowed.

Roll cages are mandatory and must be mounted inside of the cab.

Engine classes allowed are: ALL ICE Engine Classes.

5.G.7 Unlimited Diesel Truck - /UDT

This class is for diesel trucks modified as to be illegal for the Modified Diesel truck class. Any frame and running gear may be used and multiple engines are allowed. The body may be highly modified.

Trucks weighing over 14,500 lbs. are allowed unlimited engine displacement. Full size trucks are limited to a maximum of 750 cid. Trucks based on Mid/Mini chassis are limited to a maximum of 500 cid. There are NO engine displacement class breaks; all vehicles compete for the same record. The skid plates must NOT be designed so as to form a belly pan. Roll bars are mandatory and must be mounted inside the cab.

Engine classes allowed are: ALL ICE Engine Classes.

5.H SPECIAL CONSTRUCTION CATEGORY

This category is the pinnacle of the straightaway racer's art. It contains Streamliners and open-wheeled Lakesters with a 4+ wheel configuration. Innovation is encouraged, within the rules. Modified production bodies are forbidden. Four wheel drive is allowed. It is recommended that new vehicles be submitted for a pre-event inspection by photographs and drawings.



5.H.1 Lakester - /GL, /FL, /BGL, /BFL

Cars constructed in such a way that there is no streamlining, fairing or covering of the wheels and tires. Tread width is optional so long as no part of the body or axle fairing is wider than the narrowest inner vertical plane of the tires. Wing struts must be within the inner vertical plane of the rear tires. The wing must be mounted at least 12 in. above the top of the rear tire as measured from the lowest part of the wing. Front wings must be no wider than the inner vertical plane of the narrowest set of tires.

Minimum wheelbase requirements: NONE

Engine classes allowed are: ALL ICE and Electric Engine Classes.



5.H.2 Streamliner - /GS, /FS, /BGS, /BFS

33

This class is for the all-out land speed record car. Cars in this class shall have at least four wheels, but they need not be arranged in a rectangular configuration. The design of the body is restricted only to the extent that at least two (2) wheels shall be covered.

Engine classes allowed are: ALL ICE and Electric Engine Classes.

5.H.4 Turbine Vehicle - /T

This class is for vehicles using turbine power (external combustion) as the sole means of propulsion. The vehicle shall be wheel driven. THE BODY CONFIGURATION IS UNLIMITED. The vehicle and driver shall meet all technical and safety regulations based on the speed of the existing record. The class shall be based on vehicle weight less driver.

Class I - <500 kg II - 500-1000kg III - >1000kg

5.I Electric Vehicles



The LTA, in cooperation the NEDRA (National Electric Drag Racing Association) has developed EV motor classes to allow for a compilation of EV land speed records from around the globe. NEDRA rules are used to govern Battery and Motor Specifications. All other vehicle requirements fall under LTA Rules.

NEDRA Class Validation:

Electric vehicles shall compete in an appropriate LTA class for LTA records, the EV Technical Director shall certify the NEDRA class for their records.

Electric Power Class Designation:

Electric power shall be designated in the LTA records as a fuel type:
i.e. /ESS = Electric Super Street.

5.I.1 Motor

A: SPECIAL CONSIDERATION MUST BE MADE FOR INCREASE IN SUSTAINED LOADS PLACED ON LSR VEHICLES COMPARED TO DRAG VEHICLES. MOTORS, WIRING, AND COOLING MAY NEED TO BE UPGRADED TO REFLECT THESE CONDITIONS.

B: Vehicle must be powered by electric motor(s) only.

C: Cars - Maximum allowed motor output shaft centerline height is 24".

D: Trucks - Maximum allowed motor output shaft centerline height is 36".

E: Exposed-motor vehicles with open frame, vented, or brush window motors must install a motor shield, minimum 0.024-inch steel or 0.032-inch aluminum, or 0.120-inch Lexan.

5.I.2 ICE Fuel System

All conversion vehicles must remove fuel tanks and fuel system, including vapor storage equipment, from vehicle.

5.I.3 Transmission See 3.H.1

5.I.4 Transmission Shields See 3.H

5.I.4 Drive Lines See 3.S

5.I.5 Rearend

Chain drive vehicles must be equipped with a chain guard constructed with minimum 0.125-inch steel or 0.250-inch aluminum, covering width and top of chain to centerline of sprockets.

5.I.6 Deflector Plate - Open-bodied vehicle

Each vehicle must protect the driver from motor plasma, flying commutator bars, molten copper, bursting batteries, and spraying electrolyte. See 3.F – Firewall for guidance.

5.I.7 Batteries

A: Must be securely mounted and sealed from the driver's compartment.

B: Must be vented to the outside of the vehicle.

C: Battery may not be located above the top of the rear or drive tires in open wheeled cars, nor outside the body lines in bodied car, except OEM vehicles.

D: Open bodied vehicles are NOT allowed to use wet cell of any kind.

E: Must be installed so as to withstand a 4G vertical and 8G horizontal load.

F: Each battery or battery pack must be secured per NEDRA guidelines.

5.I.8 Electrical Wiring

A: Traction motor and high current wiring shall be located outside the driver's compartment.

B: High VOLTAGE wiring for instruments is allowed in driver's compartment.

C: All high-voltage wiring must be located and secured to prevent contact by driver or spectators. Any wiring over 24 volts must be completely covered.

D: Traction motor wiring must be completely isolated from the chassis and must have full positive and negative leads to the battery.

E: All wiring, fuses, contactors, etc. shall have a voltage rating greater than system voltage.

5.I.8a Safety Contactor

All vehicles, except in the Production (P) class, must incorporate at least one standalone safety contactor to de-energizes the traction system.

A: Solid-state switches for the safety contactor is prohibited.

B: If controlled by low-voltage circuit, the default contactor default shall be open.

C: The safety contactor shall NOT routinely open or close under load. It must be separate from any contactor used to throttle the vehicle, or to pre-charge the controller, for example.

5.I.9 Fusing of Batteries

A: All battery packs must have over current protection.

B: Battery sub-packs must be individually fused.

C: Circuit breaker(s) or fuse(s) are permitted.

5.I.10 Charging

A: Batteries may be charged in the pits or other designated areas only.

B: Vehicle must be attended and monitored during entire charging process.

C: Vehicle must be connected to AC power supply ground when charging.

D: Charger must have appropriate internal fuse.

5.I.11 Ignition

A: A RED marker must be clearly visible when the power system is turned on. This may be a light or a mechanical indicator. (Excludes OEM).

B: An externally activated switch or switch control must be installed on the rear of the vehicle and clearly marked to indicate OFF position.

C: Traction battery pack must be physically disconnected when switch is in the off position.

5.I.12 Battery Pack Voltage Classes

Class	Nominal Voltage	Measured Voltage
A5	600V	>600V**
A4	540V	448.9V – 600V
A3	408V	382.9V - 448.8V
A2	348V	330.1V - 382.8V
A	300V	264.1V - 330.0V
B	240V	211.3V - 264.0V
C	192V	184.9V - 211.2V
D	168V	158.5V - 184.8V
E	144V	132.1V - 158.4V
F	120V	105.7V - 132.0V
G	96V	79.3V - 105.6V
H	72V	52.9V - 79.2V
I	48V	26.5V – 52.8V
J	24V	0 - 26.4V

Please visit www.nedra.com for more information.

5.J 36HP ENGINE VW (LTA &ECTA ONLY)

The 36 HP challenge is a compilation of land speed records from around the globe specific to VW engined vehicles. While we do maintain an affiliation with the 36HP Challenge, it does not extend beyond the sharing of records. All entrants are required to comply with all LTA rules and regulations. LTA rules supersede all 36HP rules if a discrepancy is found. **Please visit the 36hp Challenge for complete rules and classes:**

35

5.K SUPERCAR

- A. **These requirements serve as an addendum to the full requirements and rules outlined herein. All competitors shall read the preface and section 1 at a minimum to understand the requirements and procedures of the LTA.**
- B. **Be Advised: Vehicle racing is generally not covered by insurance. This can include collision, property, and liability. We strongly recommend that participants check with their carrier or agent for advice.**

5.K.1 Class Rules:

- A. This class participates in timing at the length of 1 mile. Failure to decelerate after 1 mile may be grounds for dismissal from the event.
- B. Vehicle speed is strictly limited to 195 mph. Failure to comply with this limit may be grounds for immediate dismissal of the team from the event.
- C. Heavily modified vehicles in power unit or aero may be required to compete under the LSR rules. (Consult race officials.)

5.K.2 - Classes:

- A. **Muscle Cars** - Camaros, Hellcats, BMWs, Mercs, Mustangs etc.
- B. **GT** - Porsches, Corvettes etc.
- C. **Exotics** - GTRs, Audi R8, Ferrari, Lambo etc.

5.K.3 – Safety Equipment:

- A. **HELMET:** Proper fitting full face helmet that meets SNELL M or SA 2015, or 2020, or ECE 22-05.
- B. **EYE PROTECTION:** Shatterproof glasses are required in absence of visor.
- C. **CLOTHING:** Non-synthetic fabric clothing completely covering arms, torso, and legs, full coverage footwear and leather gloves (minimum) are required.
- D. **TIRES:** DOT-approved which meet or exceed OEM speed rating in good condition are required.

VW engined 5.L Alternative Fuel Experimental/AFX4.

This class is for engine classes that is run on non-production pump fuels. Examples include: bio-diesel, peanut oil, soybean oil, hydrogen, etc.

36

1.0 CLASS 1.5
Loring Timing Association
Official Car Records
May 17, 2023

VEH #	DATE	DRIVER	TEAM	1.0	CLASS	1.5	VEH #	DRIVER	TEAM	DATE	
SUPERSTREET - /SS											
9162	07/14	JOE ANTHONY	ATLANTIC AUTO RACING	170.582	A/6SS	187.128	9249	WINSTON CHURCHILL	CHURCHILL RACING	07/12	
9162	07/16	SCOTT GIEBLER	ATLANTIC AUTO RACING	171.796	A/6SS	183.136	9162	JOE ANTHONY	ATLANTIC AUTO RACING	07/14	
9162	07/17	SCOTT GIEBLER	ATLANTIC AUTO RACING	172.233	A/6SS	170.172	9946	JOHN SULLIVAN	JES RACING	09/17	
9930	07/16	DON WARREN	WARREN RACING	201.219	A/6SS	215.521	9930	DON WARREN	WARREN RACING	07/16	
9162	07/13	JOE ANTHONY	ATLANTIC AUTO RACING	173.195	A/6SS	182.521	9162	JOE ANTHONY	ATLANTIC AUTO RACING	07/12	
9162	07/16	JOE ANTHONY	ATLANTIC AUTO RACING	173.105	A/6SS	179.014	9162	JOE ANTHONY	ATLANTIC AUTO RACING	07/14	
1837	07/22	JAMES DUNN	JIMISH RACING	176.012	A/6SS	180.664	1837	JAMES DUNN	JIMISH RACING	07/22	
9162	07/17	SCOTT GIEBLER	ATLANTIC AUTO RACING	170.843	A/6SS	165.022	1084	JORDAN HANSON	MAINE BARONS RACING	09/20	
9866	07/13	PIERRE BABIN	FABRI-TECH RACING	180.888	B/6SS	186.705	9866	PIERRE BABIN	FABRI-TECH RACING	07/13	
9866	07/14	PIERRE BABIN	FABRI-TECH RACING	195.366	B/6SS	190.844	9866	PIERRE BABIN	BABIN RACING	07/22	
9946	09/18	ELE SULLIVAN	JES RACING	169.391	B/6SS	179.054	9946	ELE SULLIVAN	JES RACING	07/18	
9778	07/14	JASON THERIAULT	JRT CUSTOMS	206.234	B/6SS	214.152	9778	JASON THERIAULT	JRT CUSTOMS	07/14	
9222	07/18	CONNIE ROBERTS	PLUM CRAZY RACING	192.712	C/6SS	201.920	9222	ERNEST CAISSIE	PLUM CRAZY RACING	07/18	
9162	07/14	JOE ANTHONY	ATLANTIC AUTO RACING	173.093	C/6SS	178.783	9162	JOE ANTHONY	ATLANTIC AUTO RACING	07/11	
9222	09/20	EARNEST CAISSIE	PLUM CRAZY RACING	191.364	C/6SS	209.903	9222	EARNEST CAISSIE	PLUM CRAZY RACING	09/20	
9778	08/13	JASON THERIAULT	JRT CUSTOMS	189.382	C/6SS	203.419	9778	JASON THERIAULT	JRT CUSTOMS	08/13	
9408	07/21	NICK VERONIE	THURMONT AUTO SALES	148.564	D/6SS	155.240	9408	NICK VERONIE	THURMONT AUTO SALES	07/21	
1990	09/15	JET MCGARITY	JET POWERED RACING	136.095	D/6SS	141.727	1990	JET MCGARITY	JET POWERED RACING	09/15	
9946	04/15	ELE SULLIVAN	JES RACING	154.941	D/6SS	163.571	9946	ELE SULLIVAN	JES RACING	04/15	
9778	07/13	JASON THERIAULT	JRT CUSTOMS	152.857	D/6SS	207.203	9778	JASON THERIAULT	JRT CUSTOMS	07/13	
9408	07/21	NICK VERONIE	THURMONT AUTO SALES	150.523	E/6SS	157.434	9408	NICK VERONIE	THURMONT AUTO SALES	07/21	
9935	07/22	WENDELL WASHINGTON	DAMAGE INC	143.954	E/6SS	154.374	9935	WENDELL WASHINGTON	DAMAGE INC	07/22	
9946	08/14	ELE SULLIVAN	JES RACING	145.470	E/6SS	154.918	9946	ELE SULLIVAN	JES RACING	08/14	
9617	07/15	MIKE REICHEN	REICHEN RACING	200.137	F/6SS	198.478	9617	MIKE REICHEN	REICHEN RACING	07/15	
9408	07/19	NICK VERONIE	THURMONT AUTO SALES RACING	153.014	F/6SS	156.359	9408	NICK VERONIE	THURMONT AUTO SALES RACING	07/19	
9408	07/21	NICK VERONIE	THURMONT AUTO SALES	147.909	F/6SS	155.159	9408	NICK VERONIE	THURMONT AUTO SALES	07/21	
9946	09/15	ELE SULLIVAN	JES RACING	156.249	F/6SS	166.592	9946	ELE SULLIVAN	JES RACING	07/16	
9408	07/21	NICK VERONIE	THURMONT AUTO SALES	151.413	F/6SS	173.486	9778	JASON THERIAULT	JRT CUSTOMS	07/11	
9945	04/15	KATE SULLIVAN	JES RACING	118.762	G/6SS	129.393	9945	FERNANDO STELSER	STELSER RACING	07/10	
9946	09/15	ELE SULLIVAN	JES RACING	151.196	G/6SS	161.469	9946	ELE SULLIVAN	JES RACING	09/15	
514	08/19	ADAM MILLER	AD SPEED MOTORSPORTS	161.301	G/6SS	154.346	514	ADAM MILLER	AD SPEED MOTORSPORTS	08/19	
9945	08/14	JOHN SULLIVAN	JES RACING	123.099	H/6SS	127.159	9945	JOHN SULLIVAN	JES RACING	08/14	
9202	08/14	ADRIAN TAUER	TEAM TIAMAT RACING	144.503	H/6SS	153.016	9202	ADRIAN TAUER	TEAM TIAMAT RACING	08/14	
9589	04/15	JOHN SULLIVAN	JES RACING	68.758	I/6SS	68.679	9589	JOHN SULLIVAN	JES RACING	04/15	
					I/6SS	89.311	9435	PHILLIP REID	REID RACING	07/10	
					A/6SS	108.412	9410	DAVID COVER	COVER RACING	07/12	
REAL STREET - /RS											
802	07/13	IAIN MACARTHUR	DEATHPROOF RACING	201.985	A/6RS	218.271	802	IAIN MACARTHUR	DEATHPROOF RACING	07/13	
802	07/14	IAIN MACARTHUR	DEATHPROOF RACING	213.909	A/6RS	219.916	802	IAIN MACARTHUR	DEATHPROOF RACING	07/14	
					A/6RS	171.680	9321	GEORGE BROCKMAN	BIRDMAN RACING	08/09	

VEH #	DATE	DRIVER	TEAM	CLASS	1.0	1.5	VEH #	DRIVER	TEAM	DATE
9769C	07/16	CARL THERIAULT	ZOOMZOOMZOOM RACING	144.873 A/FRS	155.787	9769C	CARL THERIAULT	ZOOMZOOMZOOM RACING	07/16	
9222	07/22	MARK MAYBURY	MAYBURY RACING	208.735 B/FRS	223.330	9222	MARK MAYBURY	MAYBURY RACING	07/22	
9222	08/14	MARK MAYBURY	MAYBURY RACING	181.333 B/FRS	191.440	9222	MARK MAYBURY	MAYBURY RACING	08/14	
9222	08/19	MICHAEL MAYBURY	MAYBURY RACING	196.075 C/FRS	209.307	9222	MICHAEL MAYBURY	MAYBURY RACING	08/19	
9769C	07/16	CARL THERIAULT	ZOOMZOOMZOOM RACING	150.571 C/FRS	161.415	9769C	CARL THERIAULT	ZOOMZOOMZOOM RACING	07/16	
9935	09/21	WENDELL WASHINGTON	DAMAGE INC.	136.624 E/GRS	143.356	9935	WENDELL WASHINGTON	DAMAGE INC.	09/21	
9935	08/18	WENDELL WASHINGTON	DAMAGE INC.	136.870 F/GRS	146.756	9935	WENDELL WASHINGTON	DAMAGE INC.	08/18	
9935	08/18	TED FOTOPPOULOS	DAMAGE INC.	138.304 F/FRS	150.601	9935	TED FOTOPPOULOS	DAMAGE INC.	08/18	
PRODUCTION - /PRO										
9162	07/16	JOE ANTHONY	ATLANTIC AUTO RACING	173.621 A-/PRO	202.361	9978	FRED MULLAVER	FSH RACING	07/11	
9162	07/17	JOE ANTHONY	ATLANTIC AUTO RACING	172.731 A/PRO	203.592	9978	FRED MULLAVER	FSH RACING	07/11	
9162	07/16	JOE ANTHONY	ATLANTIC AUTO RACING	174.656 B/PRO	202.311	9978	JEFF JACOBS	FSH RACING	07/11	
9162	07/16	JOE ANTHONY	ATLANTIC AUTO RACING	174.227 C/PRO	202.868	9978	JEFF JACOBS	FSH RACING	07/11	
9408	07/21	NICK VERONIE	THURMONT AUTO SALES	146.927 D/PRO	154.266	9408	NICK VERONIE	THURMONT AUTO SALES	07/21	
9408	07/21	NICK VERONIE	THURMONT AUTO SALES	149.846 E/PRO	155.447	9408	NICK VERONIE	THURMONT AUTO SALES	07/21	
9408	07/21	NICK VERONIE	THURMONT AUTO SALES	147.435 F/PRO	154.634	9408	NICK VERONIE	THURMONT AUTO SALES	07/21	
9945	09/15	JOHN SULLIVAN	JES RACING	120.511 G/PRO	126.466	9945	JOHN SULLIVAN	JES RACING	09/15	
RT-66	07/17	TOM DALY	FAIRWAY MOTORSPORTS	100.100 X0/PRO	104.964	RT-66	TOM DALY	FAIRWAY MOTORSPORTS	07/17	
PRODUCTION SUPERCHARGED - /PS										
9946	07/18	JOHN SULLIVAN	JES RACING	170.834 A-/PS	181.063	9946	ELE SULLIVAN	JES RACING	07/18	
9946	09/17	ELE SULLIVAN	JES RACING	159.151 A/PS	167.704	9946	ELE SULLIVAN	JES RACING	09/17	
9946	07/18	ELE SULLIVAN	JES RACING	172.698 B/PS	183.447	9946	ELE SULLIVAN	JES RACING	07/18	
863	07/13	TERRY RUSSELL	RED COBRA RACING	179.575 C/PS	191.786	863	TERRY RUSSELL	RED COBRA RACING	07/13	
878	07/18	ANDY ANDERSON	STINGRAY RACING	192.874 D/PS	194.227	878	ANDY ANDERSON	STINGRAY RACING	07/18	
2	07/19	BOB IDA	IDA AUTOMOTIVE	186.730 E/PS	194.188	2	BOB IDA	IDA AUTOMOTIVE	07/19	
L124	07/14	BILL LONG	BOX GUY RACING	153.966 F/PS	161.205	L124	BILL LONG	BOX GUY RACING	07/14	
9946	08/14	ELE SULLIVAN	JES RACING	146.208 G/PS	154.482	9946	ELE SULLIVAN	JES RACING	08/14	
9202	08/13	ADRIAN TAUER	TEAM TIAMAT RACING	138.659 H/PS	147.234	9202	ADRIAN TAUER	TEAM TIAMAT RACING	08/13	
GRAND TOURING - /GT										
65	08/19	ROBERT GOBIEL	GOBIEL RACING	200.884 A-/GT	213.716	65	ROBERT GOBIEL	GOBIEL RACING	08/19	
9288	07/16	JASON WHITE	RECMECH MOTORSPORTS	223.345 A-/BGT	243.556	9288	JASON WHITE	RECMECH MOTORSPORTS	07/16	
9288	08/14	JASON WHITE	RECMECH MOTORSPORTS	164.326 A/GT	175.875	9288	JASON WHITE	RECMECH MOTORSPORTS	08/14	
9288	09/16	JASON WHITE	RECMECH MOTORSPORTS	225.813 A/BGT	246.407	9288	JASON WHITE	RECMECH MOTORSPORTS	09/16	
9160	09/17	THOMAS POOLE JR	QUICK SILVER RACING	201.123 B/BGT	183.871	9222	MARK MAYBURY	MAYBURY RACING	09/11	
922	09/20	MARK MAYBURY	MAYBURY RACING	205.304 C/GT	213.806	9160	RANDY POOLE	QUICK SILVER RACING	09/17	
9408	09/18	#REF!	TRACES AUTO RACING	186.969 C/BGT	218.018	9222	MARK MAYBURY	MAYBURY RACING	08/19	
658	07/16	BOB SIRNA	RGS MOTORSPORTS	172.058 D/GT	148.713	658	BOB SIRNA	RGS MOTORSPORTS	07/16	
658	07/16	BOB SIRNA	RGS MOTORSPORTS	172.767 E/GT	190.884	658	BOB SIRNA	RGS MOTORSPORTS	07/16	
658	07/16	BOB SIRNA	RGS MOTORSPORTS	171.270 F/GT	185.974	658	BOB SIRNA	RGS MOTORSPORTS	07/16	
658	07/16	BOB SIRNA	RGS MOTORSPORTS	171.771 G/BGT	150.509	343	SUPPLY WEIPANICH	WANNER RACING	09/11	

VEH #	DATE	DRIVER	TEAM	1.0	CLASS	VEH #	DRIVER	TEAM	DATE
STREET ROADSTER - /STR									
55	07/16	JOE LEDFORD	LEADFOOT RACING	195.341	B/STR	216.596	JOE LEDFORD	LEADFOOT RACING	08/09
1946	07/14	STEVE VAN BLARCOM	VAN BLARCOM/GILMORE	200.429	C/STR	210.358	DOUG KENNY	DOUG KENNY RACING	08/10
1946	07/14	STEVE VAN BLARCOM	VAN BLARCOM/GILMORE	201.086	D/BSTR	204.629	STEVE VAN BLARCOM	VAN BLARCOM/GILMORE	07/14
206.720	1946	STEVE VAN BLARCOM	VAN BLARCOM/GILMORE						
ROADSTER - /R									
260	07/18	ED BRACE	BRACES GREENHOUSE	128.962	AA/FR	132.616	ED BRACE	BRACES GREENHOUSE	07/22
1946	09/12	STEVE VAN BLARCOM	VAN BLARCOM/GILMORE	210.040	AA/BFR	218.374	STEVE VAN BLARCOM	VAN BLARCOM/GILMORE	08/17
260	07/19	ED BRACE	BRACES GREENHOUSE	122.535	A/GR	128.557	ED BRACE	BRACES GREENHOUSE	07/19
260	09/17	ED BRACE	BRACES GREENHOUSE	129.582	A/FR	135.434	ED BRACE	BRACES GREENHOUSE	07/11
260	07/16	ED BRACE	BRACES GREENHOUSE	136.912	B/FR	219.808	RON SAN GIOVANNI JR	VAN BLARCOM/GILMORE	07/11
					C/GR	145.108	ED BRACE	BRACES GREENHOUSE	07/16
						120.803	2114	CARTER LLOYD	NO TIME TO LOSE RACING
260	07/16	ED BRACE	BRACES GREENHOUSE	135.351	C/FR	143.604	ED BRACE	BRACES GREENHOUSE	07/16
2114	07/17	BOB PETERS	NO TIME TO LOSE RACING	172.035	D/GR	183.202	BOB PETERS	NO TIME TO LOSE RACING	07/17
1946	07/13	STEVE VAN BLARCOM	VAN BLARCOM/GILMORE	208.007	D/BGR	211.675	STEVE VAN BLARCOM	VAN BLARCOM/GILMORE	07/10
9600	07/19	RON SAN GIOVANNI JR	SCOTTYS ROADSTER	189.346	XXF/BGR	217.823	STEVE VAN BLARCOM	VAN BLARCOM/GILMORE	07/11
7230	09/15	BRIAN KETTERER	KOWALSKI RACING	107.181	V4F/GR	167.128	BOB JEPSON	JEPSON RACING	07/11
200.655	9600	RON SAN GIOVANNI JR	SCOTTYS ROADSTER			9339	BOB JEPSON	JEPSON RACING	07/19
110.958	7230	BRIAN KETTERER	KOWALSKI RACING				BRIAN KETTERER	KOWALSKI RACING	09/15
MODIFIED ROADSTER - /MR									
335	09/15	KEN MAKUCH	MAKUCH RACING	159.879	XF/FMR	202.935	LARRY ILLINGSWORTH	ERLI DAYS RACING	08/09
508	07/16	LAWSON CHENOWETH	CHENOWETH RACING	152.842	V4/GMR	69.057	ED RUGGERI	ERLI DAYS RACING	08/09
						166.454	335	KEN MAKUCH	MAKUCH RACING
						154.488	508	LAWSON CHENOWETH	CHENOWETH RACING
REAR ENGINE MODIFIED ROADSTER - /MR									
5150	07/22	EARNEST CAISSIE	PLUM CRAZY RACING	136.241	AA/FRMR	130.544	EARNEST CAISSIE	PLUM CRAZY RACING	07/22
27	07/17	BRAD ROORDA	PIGASUS RACING	201.044	AA/BFRMR	198.308	27	BRAD ROORDA	PIGASUS RACING
260	07/13	ED BRACE	BRACES GREENHOUSE	137.055	A/FRMR	142.796	ED BRACE	BRACES GREENHOUSE	07/13
8150	07/18	JEFF ARNETT	RON'S HOBBY SHOP	179.100	A/BGRMR	196.740	8150	JEFF ARNETT	RON'S HOBBY SHOP
27	07/17	CALVIN SMITH	PIGASUS RACING	201.654	A/BFRMR	130.252	27	CALVIN SMITH	PIGASUS RACING
260	08/13	ED BRACE	BRACES GREENHOUSE	134.582	B/GRMR	141.090	260	ED BRACE	BRACES GREENHOUSE
8150	09/20	JEFF ARNETT	RON'S HOBBY SHOP SPECIAL	187.944	B/BGRMR	208.581	8150	JEFF ARNETT	RON'S HOBBY SHOP SPECIAL
8150	07/22	RON SAN GIOVANNI	RON'S HOBBY SHOP	178.190	B/FRMR	198.367	8150	RON SAN GIOVANNI	RON'S HOBBY SHOP
260	07/13	ED BRACE	BRACES GREENHOUSE	134.401	C/FRMR	141.614	260	ED BRACE	BRACES GREENHOUSE
260	07/13	ED BRACE	BRACES GREENHOUSE	131.081	C/FRMR	137.875	260	ED BRACE	BRACES GREENHOUSE
260	07/14	ED BRACE	BRACES GREENHOUSE	151.950	C/BGRMR	164.256	260	ED BRACE	BRACES GREENHOUSE
					C/BFRMR	157.441	260	ED BRACE	BRACES GREENHOUSE
					D/GRMR	138.000	260	ED BRACE	BRACES GREENHOUSE
					D/FRMR	143.375	260	ED BRACE	BRACES GREENHOUSE

VEH #	DATE	DRIVER	TEAM	1.0	CLASS	1.5	VEH #	DRIVER	TEAM	DATE
8150	07/22	CARLY MOODY	ROW'S HOBBY SHOP	132.461	D/BGRMR	175.534	260	ED BRACE	BRACES GREENHOUSE	08/09
8150	07/22	CARLY MOODY	ROW'S HOBBY SHOP	161.110	D/BFRMR	160.852	260	ED BRACE	BRACES GREENHOUSE	07/10
7600	07/22	AMELIA COSGROVE	DAS BULLET II	182.356	F/BGRMR	169.672	7600	AMELIA COSGROVE	DAS BULLET II	07/22
7600	07/22	JIM COSGROVE	DAS BULLET II	167.596	F/BFRMR	178.892	7600	JIM COSGROVE	DAS BULLET II	07/22
8150	07/21	RON SAN GIOVANNI	ROW'S HOBBY SHOP	191.438	XF/BGRMR	208.442	8150	RON SAN GIOVANNI	ROW'S HOBBY SHOP	07/21
8150	07/16	RON SAN GIOVANNI JR	ROW'S HOBBY SHOP	169.233	XF/BFRMR	179.483	8150	RON SAN GIOVANNI JR	ROW'S HOBBY SHOP	07/16
8150	09/20	RON SAN GIOVANNI SR	ROW'S HOBBY SHOP SPECIAL	204.194	XF/BFRMR	224.681	8150	RON SAN GIOVANNI SR	ROW'S HOBBY SHOP SPECIAL	09/20
8150	09/20	RON SAN GIOVANNI JR	ROW'S HOBBY SHOP SPECIAL	206.769	XF/BFRMR	229.088	8150	RON SAN GIOVANNI JR	ROW'S HOBBY SHOP SPECIAL	09/20
AMERICAN IRON ROADSTER - /AIR										
1771	07/18	BOB PARKER	C&A MOTORSPORTS	170.841	C/AIR	182.903	1771	BOB PARKER	C&A MOTORSPORTS	07/18
COMPETITION COUPE - /CC										
9309	07/16	KIRK ASSELYN	ASSELYN RACING	176.104	AA/GCC	174.283	9309	KIRK ASSELYN	ASSELYN RACING	07/16
1034	07/14	JORDAN HANSON	MAINE BARONS RACING	170.766	A/GCC	182.578	1034	JORDAN HANSON	MAINE BARONS RACING	07/14
9309	07/22	KIRK ASSELYN	ASSELYN RACING	168.673	B/GCC	190.128	1034	ROBERT BIDEN	SAM SAMPSON COUPE	09/11
9309	05/16	KIRK ASSELYN	ASSELYN RACING	173.881	C/GCC	184.841	1034	JORDAN HANSON	SAM SAMPSON COUPE	05/16
9407	08/19	DON VOLK	BLEEDING SPEED	170.708	C/FCC	179.488	9407	DON VOLK	BLEEDING SPEED	08/19
9309	08/19	KIRK ASSELYN	ASSELYN RACING	165.727	C/BGCC	97.531	9309	KIRK ASSELYN	ASSELYN RACING	08/19
9309	07/15	KIRK ASSELYN	ASSELYN RACING	162.556	D/GCC	169.170	9309	KIRK ASSELYN	ASSELYN RACING	07/15
L155A	07/17	ALAN MANES	RAVEN RACING	199.771	D/FCC	220.069	799	JACK BATEMAN	BATEMAN RACING	07/17
L155A	07/17	ALAN MANES	RAVEN RACING	162.556	D/GCC	169.170	9309	KIRK ASSELYN	ASSELYN RACING	07/15
L125	07/14	RICK MILLER	SELFRIEDGE RACING	148.214	F/BGCC	129.895	9493	CYRUS CLARK	CYRUS CLARK	07/11
L125	07/14	RICK MILLER	SELFRIEDGE RACING	148.214	F/BGCC	185.108	9477	RANSOM HOLBROOK	HOLBROOK SHO	08/09
ALTERED -/ALT										
9769	07/14	CARL THERIAULT	ZOOMZOOMZOOM RACING	190.374	AA/GALT	201.098	9769	CARL THERIAULT	ZOOMZOOMZOOM RACING	07/14
9769	07/14	CARL THERIAULT	ZOOMZOOMZOOM RACING	209.581	AA/FALT	219.430	9769	CARL THERIAULT	ZOOMZOOMZOOM RACING	07/14
9769	08/14	CARL THERIAULT	ZOOMZOOMZOOM RACING	195.407	AA/BGALT	209.160	9769	CARL THERIAULT	ZOOMZOOMZOOM RACING	08/14
9930	09/16	BRIAN ACTON	GEEZER RACING	208.703	AA/BFALT	227.524	9930	BRIAN ACTON	GEEZER RACING	09/16
9769	07/16	CARL THERIAULT	ZOOMZOOMZOOM RACING	193.919	A/GALT	208.015	9095	JIM CLEMENS	MCKINNEY & BUTLER	07/12
9769	07/14	CARL THERIAULT	ZOOMZOOMZOOM RACING	207.214	A/FALT	221.569	9769	CARL THERIAULT	ZOOMZOOMZOOM RACING	07/14
862	09/20	BRIAN HUFFMAN	TEAM HUFFMAN RACING	228.312	A/BGALT	242.866	862	BRIAN HUFFMAN	TEAM HUFFMAN RACING	09/20
862	09/20	BRIAN HUFFMAN	TEAM HUFFMAN RACING	232.146	A/BFALT	233.676	9769	CARL THERIAULT	ZOOMZOOMZOOM RACING	09/17
9769	07/17	CARL THERIAULT	ZOOMZOOMZOOM RACING	193.298	B/GALT	205.909	9769	CARL THERIAULT	ZOOMZOOMZOOM RACING	07/17
9769	07/14	CARL THERIAULT	ZOOMZOOMZOOM RACING	205.107	B/FALT	220.507	9769	CARL THERIAULT	ZOOMZOOMZOOM RACING	07/14
862	09/20	BRIAN HUFFMAN	TEAM HUFFMAN RACING	232.004	B/BGALT	201.572	9769	CARL THERIAULT	ZOOMZOOMZOOM RACING	07/14
862	09/20	BRIAN HUFFMAN	TEAM HUFFMAN RACING	236.017	B/BFALT	217.918	9769	CARL THERIAULT	ZOOMZOOMZOOM RACING	07/17
9769	04/15	CARL THERIAULT	ZOOMZOOMZOOM RACING	157.336	C/GALT	167.388	9769	CARL THERIAULT	ZOOMZOOMZOOM RACING	04/15
9769	04/15	CARL THERIAULT	ZOOMZOOMZOOM RACING	172.423	C/FALT	184.929	862	BRIAN HUFFMAN	ZOOMZOOMZOOM RACING	04/15
862	07/19	BRIAN HUFFMAN	TEAM HUFFMAN RACING	223.205	C/BGALT	232.926	862	BRIAN HUFFMAN	TEAM HUFFMAN RACING	07/19
862	09/20	BRIAN HUFFMAN	TEAM HUFFMAN RACING	228.754	C/BFALT	201.252	932	LUKE KOHLER	RED HOT RACING	07/10
3590	07/15	TOM BECHTOLD	BECHTOLD RACING	136.885	D/GALT	150.929	3590	TOM BECHTOLD	BECHTOLD RACING	07/15
3590	07/15	TOM BECHTOLD	BECHTOLD RACING	139.804	D/FALT	155.161	3590	TOM BECHTOLD	BECHTOLD RACING	07/15

VEH #	DATE	DRIVER	TEAM	1.0	CLASS	1.5	VEH #	DRIVER	TEAM	DATE	
863	07/14	TERRY RUSSELL	RED COBRA RACING	192.043	D/BGALT		863	LAWSON BILHARDT	BLACKBIRD SC	07/12	
718	07/15	GARY PERKINSON	BRONX LSR	143.313	G/BGALT		863	TERRY RUSSELL	RED COBRA RACING	07/14	
					G/BFALT		718	GARY PERKINSON	BRONX LSR	07/15	
							147.984	CHRIS DOBBINS	DOBBINS RACING	08/10	
GAS COUPE - /GC											
9930	09/15	DON WARREN	WARREN RACING	186.887	AA/GC		2191	LANE WIGGERS	URGENTLY LAND SPEED	07/22	
738	07/18	GREG DRAKE	RYDIN RACING	219.932	AA/BGC		738	JAY BELL	RYDIN RACING	07/18	
2191	07/22	TODD WOODIN	URGENTLY LAND SPEED	184.830	A/GC		2191	TODD WOODIN	URGENTLY LAND SPEED	07/22	
9769	07/14	CARL THERIAULT	ZOOMZOOM RACING	188.004	A/BGC		9769	CARL THERIAULT	ZOOMZOOM RACING	07/14	
9145	07/19	CHAD DOWELL	DOWELL RACING	200.534	B/GC		9145	CHAD DOWELL	DOWELL RACING	07/19	
9769	07/14	CARL THERIAULT	ZOOMZOOM RACING	188.465	B/BGC		9769	CARL THERIAULT	ZOOMZOOM RACING	07/14	
9145	07/19	CHAD DOWELL	DOWELL RACING	209.348	C/GC		9145	CHAD DOWELL	DOWELL RACING	07/19	
9769	04/15	CARL THERIAULT	ZOOMZOOM RACING	155.228	C/BGC		9769	CARL THERIAULT	ZOOMZOOM RACING	04/15	
105	07/21	ED BLAKESLEE	BLAKESLEE RACING	163.158	D/GC		105	ED BLAKESLEE	BLAKESLEE RACING	07/21	
L147	09/15	JASON ROBEY	ROBEY RACING	125.738	E/BGC		863	TERRY RUSSELL	BLACKBIRD SC	07/11	
L147	09/15	JASON ROBEY	ROBEY RACING	125.165	F/GC		1147	JASON ROBEY	ROBEY RACING	09/15	
49	07/22	FOREST WENTWORTH	LATE START RACING	154.072	F/BGC		49	PAUL WENTWORTH	LATE START RACING	07/22	
9202	08/14	ADRIAN TAUER	TEAM TIAMAT RACING	145.446	G/BGC		9202	ADRIAN TAUER	TEAM TIAMAT RACING	08/14	
9202	08/14	ADRIAN TAUER	TEAM TIAMAT RACING	145.388	H/BGC		9202	ADRIAN TAUER	TEAM TIAMAT RACING	08/14	
MODIFIED SPORT - /MS											
65	09/20	MARCIA BARKER	GOBIEL RACING	182.028	AA/GMS		65	MARCIA BARKER	GOBIEL RACING	09/20	
216	09/21	JASON WHITE	TRAGEDY TO TRIUMPH	186.528	AA/FGMS		216	JASON WHITE	TRAGEDY TO TRIUMPH	09/21	
9288	09/17	JASON WHITE	RECMECH MOTORSPORTS	232.500	AA/BFGMS		9288	JASON WHITE	RECMECH MOTORSPORTS	09/17	
9288	07/18	JASON WHITE	RECMECH MOTORSPORTS	235.268	AA/BFGMS		9288	JASON WHITE	RECMECH MOTORSPORTS	07/18	
1990	09/15	JET MCGARITY	JET POWERED RACING	137.952	A/GMS		1990	JET MCGARITY	JET POWERED RACING	09/15	
216	07/21	JASON WHITE	TRAGEDY TO TRIUMPH	183.282	A/FGMS		195.341	JASON WHITE	TRAGEDY TO TRIUMPH	07/21	
9288	09/18	JASON WHITE	RECMECH MOTORSPORTS	239.190	A/BFGMS		215.723	BOB SELF	HALF FAST RACING	08/10	
306	07/13	GARY GUSTAFSON	GUSTAFSON RACING	184.302	B/GMS		267.422	JASON WHITE	RECMECH MOTORSPORTS	09/18	
9916	07/19	TOM DALY	FAIRWAY MOTORSPORTS	115.154	B/FMS		306	NATE GUSTAFSON	GUSTAFSON RACING	07/13	
9288	09/20	JASON WHITE	RECMECH MOTORSPORTS	232.942	B/BFGMS		9288	JASON WHITE	RECMECH MOTORSPORTS	08/09	
9288	08/19	JASON WHITE	RECMECH MOTORSPORTS	236.276	B/BFGMS		9288	JASON WHITE	RECMECH MOTORSPORTS	09/20	
2999	09/20	RON KESEKOWSKI	KESEKOWSKI RACING	240.116	C/GMS		250.871	RON KESEKOWSKI	KESEKOWSKI RACING	08/19	
2999	09/20	RON KESEKOWSKI	KESEKOWSKI BROTHERS	251.392	C/FGMS		257.445	RON KESEKOWSKI	KESEKOWSKI BROTHERS	09/20	
9808	07/22	TRACY GROSSNICKLE	TRACEY AUTO REPAIR	192.871	C/BGMS		9456	ANDREW KRAUSS	HALF FAST RACING	08/10	
1990	09/15	JET MCGARITY	JET POWERED RACING	137.297	D/GMS		143.333	JET MCGARITY	JET POWERED RACING	09/15	
1990	09/15	JET MCGARITY	JET POWERED RACING	139.755	D/FGMS		146.842	JET MCGARITY	JET POWERED RACING	09/15	
4613	09/20	ERIC HATCH	HATCH RACING	113.374	E/GMS		117.449	ERIC HATCH	HATCH RACING	08/19	
					F/BFGMS		182.466	ANDREW DIMARTINO	DIMARTINO FABRICATION	08/10	

VEH #	DATE	DRIVER	TEAM	1.0	CLASS	1.5	VEH #	DRIVER	TEAM	DATE	
805	09/15	CHARLES VENABLE	VENABLE ROD & RACE	205.729	C/GALT	187.781	805	CHARLES VENABLE	VENABLE ROD & RACE	07/11	
37	08/19	JESSE MICHAUD	FAIRWAY MOTORSPORTS	148.518	D/CFALT	149.019	37	JESSE MICHAUD	FAIRWAY MOTORSPORTS	07/11	
48	09/21	JACK WEIGAND	V-DUB STORE	98.668	G/CGALT	175.250	802	CHARLES VENABLE	VENABLE ROD & RACE	08/10	
48	09/21	JACK WEIGAND	V-DUB STORE	100.928	G/CFALT	101.570	48	JACK WEIGAND	V-DUB STORE	09/21	
9717	07/13	GEORGE GALLIMORE	BUCKWHEAT RACING	223.334	AA/CGC	241.781	9717	GEORGE GALLIMORE	BUCKWHEAT RACING	07/13	
9896	07/16	DICK CURTIS	IRON INDIAN RACING	147.133	B/CGC	179.644	9270	ANDREW NELSON	PACC RACING	08/09	
5656	07/17	ERIC HATCH	HATCH RACING	115.565	C/CGC	177.507	9270	ANDREW NELSON	PACC RACING	08/09	
1223	08/19	PAUL CALAGUIRO	CALAGUIRO BROTHERS RACING	148.365	F/CGC	176.442	9270	ANDREW NELSON	PACC RACING	07/10	
						150.382	1223	PAUL CALAGUIRO	CALAGUIRO BROS	07/12	
						129.772	548	WM. MURPHY	MURPHY-SLATTERY	08/09	
VINTAGE - IV											
804	07/18	B.C. WOOD	B.C. WOOD RACING	118.936	XO/NGC	129.966	9863	ELE SULLIVAN	JES RACING	07/12	
337	09/21	RICHARD ESSELEN	COLLEGE TOWN AUTO	104.243	XF/NGC	131.045	6624	BOBBY MINIS	SCRAP IRON RACING	07/11	
430	09/20	PETER KEYSER	GREAT PUMPKIN RACING	154.432	XF/BVGC	103.707	337	RICHARD ESSELEN	COLLEGE TOWN AUTO	09/21	
						162.452	430	PETER KEYSER	GREAT PUMPKIN RACING	09/20	
PRODUCTION PICKUP - /PP											
L113	09/13	FRED HAINES	HAINES RACING	95.576	AA/PP	95.648	L113	FRED HAINES	HAINES RACING	09/13	
L114	09/13	ROBERT KILCOLLINS	KILCOLLINS RACING	117.315	A/PP	121.921	L114	ROBERT KILCOLLINS	KILCOLLINS RACING	09/13	
4494	09/20	JANIE DALY	FAIRWAY MOTORSPORTS	112.858	B/PP	114.952	9488C	FRAN WHITE	RECMECH MOTORSPORTS	09/20	
4494	09/20	JANIE DALY	FAIRWAY MOTORSPORTS	112.830	C/PP	112.103	4494	JANIE DALY	FAIRWAY MOTORSPORTS	09/20	
L117	09/13	KALEB DONOVAN	DONOVAN RACING	94.453	D/PP	94.229	L117	KALEB DONOVAN	DONOVAN RACING	09/13	
L153	07/15	TOM SHAY	SHAY RACING	102.367	F/BPP	100.957	L153	TOM SHAY	SHAY RACING	07/15	
MINI PRODUCTION PICKUP - /MPP											
9947	07/14	JOHN SULLIVAN	JES RACING	116.191	D/MPP	120.542	9947	JOHN SULLIVAN	JES RACING	07/14	
9947	09/13	JOHN SULLIVAN	JES RACING	109.006	E/MPP	113.214	9947	JOHN SULLIVAN	JES RACING	09/13	
9947	08/13	JOHN SULLIVAN	JES RACING	113.720	F/MPP	119.413	9947	JOHN SULLIVAN	JES RACING	08/13	

VEH #	DATE	DRIVER	TEAM	1.0	CLASS	1.5	VEH #	DRIVER	TEAM	DATE
		MODIFIED PICKUP - /MIP								
L208	09/15	KIRK ASSELYN	ASSELYN RACING	109.432	AA/MIP	113.138	L208	KIRK ASSELYN	ASSELYN RACING	09/15
L208	09/16	KIRK ASSELYN	ASSELYN RACING	119.626	A/MIP	123.132	I208	KIRK ASSELYN	ASSELYN RACING	09/16
L208	09/20	KIRK ASSELYN	ASSELYN RACING	117.315	C/MIP	121.681	L208	KIRK ASSELYN	ASSELYN RACING	09/20
9149	07/13	SHAWN MCKAY	AFFORDABLE PERFORMANCE	121.266	C/BMIP	101.601	9149	SHAWN MCKAY	AFFORDABLE PERFORMANCE	07/13
8000	07/21	DARYL VICTOR	VICTOR RACING	107.275	E/MIP	111.677	8000	DARYL VICTOR	VICTOR RACING	07/21
		MINI MODIFIED PICKUP - /MMIP								
874	07/14	RODNEY KING	RK RACING	103.027	B/MMIP	105.863	874	RODNEY KING	RK RACING	07/14
1236	09/16	JOHN RITTER	ITTER MOTORSPORTS LSR	155.744	C/MMIP	173.194	1236	JOHN RITTER	ITTER MOTORSPORTS LSR	09/16
1236	09/16	JOHN RITTER	ITTER MOTORSPORTS LSR	156.583	D/MMIP	175.289	1236	JOHN RITTER	ITTER MOTORSPORTS LSR	09/16
		DIESEL TRUCK - /DT								
L108	09/13	RALPHIE NAVARRO	NAVARRO RACING	136.031	AA/DT	130.996	L108	RALPHIE NAVARRO	NAVARRO RACING	09/13
L108	08/13	RALPHIE NAVARRO	NAVARRO RACING	127.973	A/DT	133.509	L108	RALPHIE NAVARRO	NAVARRO RACING	08/13
L600	07/19	ROBERT SWARTZ	MOTUS OF NEW ENGLAND	128.680	B/DT	136.335	L600	ROBERT SWARTZ	MOTUS OF NEW ENGLAND	07/19
5678	07/22	JACOB SIMS	LAZY MUTT RACING	126.639	E/DT	133.362	5678	JACOB SIMS	LAZY MUTT RACING	07/22
5678	07/22	DAN STOKES	LAZY MUTT RACING	132.373	F/DT	139.135	5678	DAN STOKES	LAZY MUTT RACING	07/22
		MODIFIED DIESEL TRUCK - /MDT								
L129	05/16	MARK DUNBAR	HOT WATER RACING	109.367	AA/MDT	109.269	L129	MARK DUNBAR	HOT WATER RACING	05/16
L108	07/14	RALPHIE NAVARRO	NAVARRO RACING	138.883	A/MDT	143.279	L108	RALPHIE NAVARRO	NAVARRO RACING	07/14
1189	09/20	JORDAN HANSON	MAINE BARONS RACING	105.983	B/MDT	105.683	1189	JORDAN HANSON	MAINE BARONS RACING	09/20
		UNLIMITED DIESEL TRUCK - /UDT								
		LAKESTER - /L								
608	05/16	DON BIGLOW	DUAERHEIM BILGLOW	232.879	AA/GL	247.545	608	DON BIGLOW	DUAERHEIM BILGLOW	05/16
1733	07/18	BOB JINKENS	MCLAIN-JINKENS RACING	225.865	AA/GL	222.657	1733	BOB JINKENS	MCLAIN-JINKENS RACING	07/18
9909	08/14	JEROME BEST	ASSELYN RACING	160.683	AA/BGL	133.260	9909	JEROME BEST	ASSELYN RACING	08/14
553	08/19	TOM HAAS	HAAS & SHIPLEY	206.855	A/GL	211.952	553	TOM HAAS	HAAS & SHIPLEY	08/19
1733	07/15	BOB JINKENS	MCLAIN/JINKENS RACING	205.257	A/GL	106.012	1733	BOB JINKENS	MCLAIN/JINKENS RACING	07/15
990	07/12	JOHN OKALY	CHEEP SPEED RACING	172.933	A/BGL	175.655	990	JOHN OKALY	CHEEP SPEED RACING	07/12
553	08/19	DAVID HAAS	HAAS & SHIPLEY	206.991	B/GL	212.716	553	DAVID HAAS	HAAS & SHIPLEY	08/19
9263	07/15	KENT SIRIMOGU	KMS RACING	212.430	B/GL	210.162	9263	BOB JINKENS	MCLAIN/JINKENS RACING	07/16
990	09/15	JOHN OKALY	CHEEP SPEED RACING	225.361	B/BGL	250.758	990	JOHN OKALY	CHEEP SPEED RACING	09/15
9365	09/20	MICHAEL BROWN	ITISFORFREEDOM	208.913	B/BFL	223.347	7600	JIM COSGROVE	DAS BULLET	08/19
9909	09/10	JEROME BEST	ASSELYN RACING	170.072	C/GL	180.385	9973	ANDREW MURRAY	MURRAY RACING	08/10
9909	07/14	KIRK ASSELYN	ASSELYN RACING	155.544	C/BGL	158.639	9309	KIRK ASSELYN	ASSELYN RACING	07/14
7600	09/17	DENNIS COSGROVE	DAS BULLET	197.086	C/BFL	217.957	7600	DENNIS COSGROVE	DAS BULLET	09/17
9909	07/13	KIRK ASSELYN	ASSELYN RACING	149.291	D/GL	152.191	9909	KIRK ASSELYN	ASSELYN RACING	07/13
9909	04/15	KIRK ASSELYN	ASSELYN RACING	153.126	D/FL	157.736	9909	KIRK ASSELYN	ASSELYN RACING	04/15
7600	09/17	JIM COSGROVE	DAS BULLET	194.915	D/BGL	215.378	7600	JIM COSGROVE	DAS BULLET	09/17

VEH #	DATE	DRIVER	TEAM	1.0	CLASS	1.5	VEH #	DRIVER	TEAM	DATE
7600	08/13	JIM COSGROVE	DAS BULLET	202.039	D/BGL	212.029	7600	JIM COSGROVE	DAS BULLET	08/13
7600	07/15	JIM COSGROVE	DAS BULLET	194.902	E/BGL	217.967	7600	JIM COSGROVE	DAS BULLET	07/15
7600	09/13	DENNIS COSGROVE	DAS BULLET	184.182	F/BFL	204.473	7600	DENNIS COSGROVE	DAS BULLET	09/13
7600	07/18	JIM COSGROVE	DAS BULLET	188.436	F/BGL	206.981	7600	JIM COSGROVE	DAS BULLET	07/18
405	09/20	JACK GIFFORD	SPEED QUEEN II	140.986	F/BFL	206.982	7600	JIM COSGROVE	DAS BULLET	04/15
					G/GL	171.601	253	STEVE DIMARTINO	JESSE'S GIRL	08/10
					I/GL	149.867	259	LEE LEVANT	LEE LEVANT	09/11
					I/FL	180.026	259	LEE LEVANT	LEE LEVANT	09/11
1445	07/14	ERIC HATCH	HATCH RACING	74.568	J/GL	73.361	1445	ERIC HATCH	HATCH RACING	07/14
1445	07/15	ERIC HATCH	HATCH RACING	71.543	J/FL	69.828	1445	ERIC HATCH	HATCH RACING	08/14
2255	09/15	ANDREW WELKER	BLONDE BITCH RACING	154.343	XF/GL	166.011	9796	MICHAEL ROMAN	WOUNDED WARRIORS	07/10
8150	07/14	RON SAN GIOVANNI	RON'S HOBBY SHOP	174.874	XF/BGL	166.085	2255	ANDREW WELKER	BLONDE BITCH RACING	09/15
7231	09/15	E.J. KOWALSKI	KOWALSKI RACING	140.042	V4F/GL	181.815	8150	RON SAN GIOVANNI	RON'S HOBBY SHOP	07/11
2400	07/17	ROBERT SWARTZ	RDS	55.087	V4F/FL	143.008	7231	E.J. KOWALSKI	RON'S HOBBY SHOP	09/15
343	09/21	FRANK JOHN	FJ RACING	153.599	A2/EL	54.401	2400	ROBERT SWARTZ	RDS	07/17
999	07/18	ROBERT LARAVIE	FIG BOY RACING	71.007	H/EL	155.445	343	FRANK JOHN	FJ RACING	09/21
						74.220	999	ROBERT LARAVIE	FIG BOY RACING	07/18
STREAMLINER- S										
986	43293	JEFF GENTRY	RYDIN RACING	180.977	AA/GS	205.210	986	JEFF GENTRY	RYDIN RACING	07/18
7100	09/20	PAM BEINEKE	G-SERIES RACING	250.924	AA/F5	236.761	1733	BOB JINKENS	MCCLAIN/JINKENS	09/17
7100	07/18	PAM BEINEKE	G-SERIES RACING	251.137	AA/BFS	164.283	7100	PAM BEINEKE	G-SERIES RACING	07/17
1733	07/15	BOB JINKENS	MCCLAIN/JINKENS RACING	214.587	A/F5	222.090	1733	BOB JINKENS	MCCLAIN/JINKENS RACING	07/15
411	09/20	ANDREW MURRAY	MURRAY BROS RACING	208.693	B/F5	208.699	1733	BOB JINKENS	MCCLAIN/JINKENS RACING	07/16
1707	04/15	BURTON BROWN	VICTORY RACING	144.287	G/6S	202.705	411	ANDREW MURRAY	MURRAY BROS RACING	09/20
1908	07/17	JESSE MICHAUD	FAIRWAY MOTORSPORTS	99.602	BB/VWO	163.161	1707	BURTON BROWN	VICTORY RACING	04/15
48	07/19	JACK WEIGAND	WEIGAND MACHINE & DESIGN	101.221	TS1600BB III/E	100.036	1908	JESSE MICHAUD	MICHAUD RACING	08/14
						104.585	48	JACK WEIGAND	WEIGAND RACING	09/20
						112.103	9410	DAVID COVER	COVER RACING	07/11

7. MOTORCYCLES

MOTORCYCLE OVERVIEW

Motorcycle records are kept in 6 Categories:

OHC (Overhead Cam), Pushrod, 2-Stroke, Twins, Classics, Electric

Motorcycle Records are comprised of three components:

Motorcycle Class, Engine Type, Engine Displacement/Voltage

For example: MPS/CBG-1350/4

Class –Modified Partial Streamliner

Type – Classic Blown Gas

Size - 1001 - 1350cc. /4 stroke.

CHASSIS AND BODY DESCRIPTIONS

- A: Production Class is for motorcycles that are stock IN APPEARANCE.
- B: Visible engine components must be OEM for the model.
- C: Changes to the fueling system, engine, air intake, computers and exhaust system that are not apparent to exterior view are permitted.

PURE PRODUCTION (PP)

A: Production Rules. Vehicles SHALL only run in the engine class of manufacture.

PRODUCTION (P)

A: Production Rules. Vehicles MAY run up in class.

MODIFIED (M)

- A: The modified class is for motorcycles BASED on production models.
- B: No aerodynamic aids on the front. Commonly referred to as "NAKED".
- C: Removal of the front fairings is usually all that is required. (see rules.)
- D: Modifications to the other bodywork is limited.
- E: Modifications to the engine, swing arm, tank, pegs are allowed.

MODIFIED PARTIAL STREAMLINER (MPS) Same as Modified(M) with:

- A: Aerodynamic aids allowed per rules.
- B: Most modern sport bikes with a "chip and can" fall into this class.
- C: Custom bodywork is allowed as defined in the rules.

ALTERED (A)

- A: Altered is for specially constructed and purpose built race bikes.
- B: Aerodynamic front fairings are not allowed.
- C: May use 1 or 2 engines of any design.
- D: May use non-motorcycle engines. (PRIOR APPROVAL REQUIRED)

ALTERED PARTIAL STREAMLINER (APS) Same as Altered(A) with:

- A: Aerodynamic fairings allowed. The rider must be visible per the rules.
- B: Modified Class motorcycles with custom APS fairings fall into APS.

SIDECAR (SC)

- A: Modified or Altered class motorcycles with a sidecar attached.
- B: Riders are not permitted.

STREAMLINER (S) AND SIDECAR STREAMLINER (SCS)

- A: Extensive design and construction required.
- B: Roll cage, fire suppression, driver restraints, fire suit, etc. required.
- C: May use 1 or 2 engines of any design.
- D: May use non-motorcycle engines. (PRIOR APPROVAL REQUIRED)

ENGINE TYPE DESCRIPTIONS

MOTORCYCLE ENGINE DEFINITION

- A: Engines originally designed for use in motorcycles.
- b: Engines originally designed for motorsports vehicles that were also offered in motorcycles in a volume of 500 units.

NON-MOTORCYCLE ENGINE DEFINITION

- A: Engine originally designed for automobiles or non-transportation purposes.
- B: Motorsports engines not sold in motorcycles in a volume of 500+ units.

PURE PRODUCTION & PRODUCTION– (PP & P) For all engine classes.

Production engines must be the same model as the model of the frame being used and must have STOCK EXTERNAL APPEARANCE with OEM cylinders, heads and crankcases. OEM engine displacement determines the displacement class for competition. Starter must be retained and

operable. Carburetors or throttle bodies must be OEM for that model production engine. ALL PRODUCTION ENGINES RUN IN GAS (G) CLASS.

VINTAGE – (V) For all Engine Classes except Classic.

Limited to motorcycle engines produced prior to 1956. **Non-OEM cases and heads allowed so long as dimensionally equivalent to OEM.**

2-STROKE (/2)

Defined as an engine operating in a 2-cycle fashion.

- A: Motorcycle Engines Only - Production and Modified Frame Classes.
- B: Any 2-stroke engine – Altered Class.

OHC

An engine with overhead cam operated valves as defined below.

The camshaft location must fall within the following limitations:

- A: Above the valve train.
- B: No more than the crankshaft stroke below the OEM cylinder deck.
- C: Pushrod length less than twice the crankshaft stroke. (BMW air/oilhead.)

PUSHROD (P)

Any engine with push rod operated valves as defined below.

The camshaft location must fall within the following limitations:

- A: At least one crankshaft stroke below the OEM cylinder deck position.
- B: OEM pushrod length at least twice the crankshaft stroke.
- C: Replacement heads must have the same number of valves as originally produced for engines of the same series in Production.

TWIN (T)

Any 4-stroke single or twin cylinder motorcycle engine:

- A: Pushrod and OHC engines (as defined above).
- B: Any cylinder angles between 0 – 180 degrees for twins allowed.
- C: Motorcycle Engines Only.

CLASSIC (C)

Any 4-stroke air cooled motorcycle engine:

- A: Manufactured between 1956 and 1986 inclusively.
- B: **Non-OEM cases and heads allowed so long as dimensionally equivalent to OEM.**
- C: Alteration of cooling fin design, size and placement is allowed.
- D: Enhanced cooling is not permitted. (ie. water injection, nitrous oxide or water spray, radiators, enlarged or modified oil systems.
- E: Fuel system may be upgraded. OEM carbureted to remain carbureted.
- F: OEM fuel injection may be retained, modified, replaced by carburetors.
- G: One distributor or magneto allowed.
- H: Computers allowed for data collection purposes only.

Electric (E)

Electric is defined as propulsion via electric motors only.

- A: Hybrid or ICE generators used to power electric drive motors not allowed.
- C: Dual drive motors allowed in Altered class only.

Electric power shall be designated in the LTA records as a fuel class:

i.e. M/E-48 =

Modified/Electric – 48 volt.

7.A GENERAL REQUIREMENTS

7.A.2 Event Procedures:

Speed Trials operating procedures shall be the same as Section 1.

7.A.4 New Race Vehicles:

It is strongly recommended that all new Altered and Special Construction class vehicles be submitted for a pre-event inspection by the Board

7.A.6 Engine:

Engine shall be defined as the primary propulsion unit of the motorcycle.

7.A.7 Rider Position:

Any reference to "Rider" position will be as follows:

Forward of the rider is defined as any area from the most forward edge of the motorcycle to the silhouette of the rider as viewed from the side, excluding the hands and arms. Behind the rider is defined as any area from the most rearward edge of the motorcycle to the silhouette of the rider from the side.

7.A.8 OEM/Original:

The term "OEM" or "original" is defined as a manufacturer's original equipment for the particular make, model and year of the motorcycle.

7.B MOTORCYCLE TECHNICAL REQUIREMENTS:

7.B.1.0 Number/Classes:

All entries must have the number and class on each side of the motorcycle, and the number and class must be clearly visible with the rider seated.

7.B.1.1 Unsafe Motorcycle:

If a Tech. Inspector or the Chief Starter judges a motorcycle unsafe it will not be allowed to compete.

7.B.2 Shut-off Requirements:

7.B.2.1 Engine Stop Switch:

All motorcycles must have a positive-off kill switch that can be operated without removing your hands from the grips.

7.B.2.2 Ignition Kill Switch Lanyard:

All motorcycles must be equipped with a tether attached to the rider so the engine ignition is shut-off if the rider becomes separated from the motorcycle. Metallic ends are required.

7.B.2.3 Fuel Pump Stop Lanyard:

If ignition kill lanyard does not disable fuel pump, the vehicle must be equipped with a tether shut-off device attached to the vehicle and the rider to shut-off the fuel pump if the rider becomes separated from the cycle.

7.B.2.4 Fuel Shutoff:

Motorcycles must have a fuel shutoff operable from a riding position. Nitrous require handle bar shutoff.

7.B.3 Fuel Systems:

The fuel system shall be well constructed and secured. Any unvalved portions, including crossover, must have fire resistant lines & fittings. Aero/quip fire sleeve cover meets this requirement. Plastic fuel lines marked for fuel applications allowed. Metal clamps shall be used on flexible fuel line. No plastic petcocks or filters allowed. Fire sleeve not required on motorcycles with electric fuel pumps if fuel pump is disabled by ignition shut off.

7.B.3.1 Fuel Types:

GAS (G) The addition of power additives to GASOLINE is prohibited. Penalty for violation of this standard shall be disqualification. See Sec. 2.C.

Fuel (F) In fuel classes, any approved liquid fuel may be used, see Sec. 2.C.

Electric (E) Defined as electrical energy stored in batteries and/or capacitors.

7.B.3.3 Alternate Fuel: (AF)

Any motorcycle using non-production pump fuels. Examples include: bio-diesel, peanut oil, soybean oil, propane hydrogen etc.

7.B.3.4 Nitrous Oxide Systems:

Nitrous Oxide bottles and lines are considered part of fuel system and governed by all fuel system rules. Bottle location shall be visibly identified.

The nitrous oxide bottle pressure relief valve shall be vented away from the engine and rider, if in an enclosed and sealed area, and shall be vented.

Nitrous oxide systems should be equipped to shut-off the nitrous oxide solenoid if the rider becomes separated from the motorcycle.

7.B.4 Cooling System:

Any combustible or flammable coolants are prohibited.

7.B.5 Batteries:

Batteries shall be secured with metal hold downs, framework and fasteners. OEM under seat box and fastener allowed. OEM hold-downs may be adequate.

7.B.6 Wheels:

OEM wheel sizes <15" may compete with prior approval. Cross-ventilated front wheels (25% min.) required except in the streamliner classes if fully enclosed by the body work. Non-cross ventilated rear wheels are allowed. Wheel disc may be installed in a workmanship type manner on the rear wheel.

7.B.7 Wheel Retention:

All axles retaining nuts must be safety wired or otherwise secured. Lock washers, self-locking nuts or thread compound do not satisfy this requirement.

7.B.8 Valve Stems and Caps:

All valve stems shall use metal caps. Over 175 MPH, metal valve stems are required. Stems that are angled away from the center of rotation must be secured to resist deflection. Safety wire is allowed.

7.B.9 Tire Requirements:

A: All motorcycles must use tires with a rating for the speed attempted.

0 to 70 MPH Any tire designed for motorcycle use is permitted.

71 to 130 Production tires with a speed rating of H or higher.

131 to 150 Production tires with a speed rating of V or higher.

151 MPH+ Production tires with a rating of ZR or racing as manufacturer designated. Production tires with a rating of V, if shaved, can be used up to 200 MPH.

200 MPH+ Experience has shown that using tires with hard rubber compounds and reducing the tread thickness by 2/3 by carefully shaving the tread provides the best results.

E: All tires rated H, V, Z or ZR must have production date codes within the last ten years of the current event.

G: Tubeless, bias ply type tires may be run with tubes.

H: Tubeless tires shall not be used on rims designed for tubed tires.

I: Drag bikes Tires drive tires are not be allowed.

J: ALL MOTORCYCLES TRAVELING OVER 200 MPH SHALL INSPECT WHEELS AND TIRES BEFORE EACH RUN.

7.B.10 Brakes:

Rear brakes are required and must be drum or disc. Actuation may be from a foot or handlebar lever. All motorcycles traveling over 175 shall have front brakes and dual master cylinders arranged so that if one becomes inoperable, the other may be used.

7.B.11 Handlebars:

All motorcycle entries must use handlebars for steering control. Handlebars must metallic. The handlebars must locate the hands outside the width of the fork tubes (6 in. minimum).

7.B.12 Throttle:

A self-closing throttle must be fitted to all motorcycles.

7.B.13 Controls:

Control levers must have at least a 1/2 in. diameter round ball end.

7.B.14 Chassis & Steering:

All parts of the steering system shall operate freely without play. Fork stops must stop travel before the hands touch the cycle. Hydraulic steering damper rod shafts do not serve as stops. A functional shock absorber is required for each sprung wheel.

7.B.15 Steering Damper:

Required in all classes over 150 MPH.

7 B 16 Chain / Belt guard:

Guards are optional. If a guard is run it must be made in a secure manner which resists deflecting and that will not allow the chain/belt to lock the rear wheel during failure. The guard must also extend over the rearward edge of the rear sprocket and forward past the forward edge of the drive sprocket. If the chain/belt is not shielded, rider's body must be protected from the chain/belt path.

7.B.17 Headlight and other lens:

All glass lenses shall be taped.

7.B.18 Windshields/Windcreens:

All windshields and windcreens shall be made of shatter resistant material.

7.B.19 Mirrors:

Must be removed unless integrated into the fairing.

7.B.20 Seat and Saddle:

No part of the seat, saddle or anything to the rear of these may be more than 42" above the ground when the vehicle is loaded. Exception: OEM.

7.B.21 Foot rests:

Footrests must be provided as per requirements of the class entered and must be used during the entire run. Foot controls must be operable with feet on the footrests. Only one set of rests is allowed.

7.B.22 Exhaust:

Exhaust outlets must be pointed away from rider, tires and race surface.

7.B.23 Ballast:

Ballast must be securely mounted ahead of the rear axle (except Streamliner) and not serve as streamlining. Visible ballast not allowed in Production.

7.B.24 Tow Starts:

Towed starts permitted for Streamliners only.

7.B.25 Oil Filter Retention:

Engine oil system must have filters safety wired to ensure retention via integral stud or bung or by wrapping the filter with a hose clamp and wired.

7.C RIDING APPAREL:

All motorcycle riders are required to use the following riding equipment, except where clearly inconsistent with Streamliner rules.

7.C.1 Rider's Helmet:

A: All drivers/riders must wear a full-face helmet with face shield.

B: Helmets will be certified to the end of their SNELL lifecycle +1 year.

C: Helmets will be visually inspected each meet to determine that it is undamaged and in serviceable condition

D: Snell M or SA 2015, 2020 or ECE 22-05 is required.

E: Snell 2015 helmets will not be allowed after 2026.

F: Riders must demonstrate proper helmet fit and "roll off" resistance.

G: Motorcycle streamliners, require SA rated helmets.

H: Eyeglasses worn under the helmet must be shatterproof.

7.C.2 Leathers:

A: Leathers suitable for the application are required.

B: One-piece or two-piece suits fully zippered together are allowed.

C: Required over 175 MPH:

1: Special protective armor, with a minimum of coverage at elbows, knees, shoulders, hips and back.

2: Undergarments having the required armor coverage are acceptable.

3: Full spine protection in required. Aerodynamic humps will not meet this requirement.

D: Perforated and vented leathers are allowed.

E: Motorcycles under 125 mph that meet the above requirements may wear full textile suits that incorporate ballistic textile.

49

7.C.3 Boots:

Zipper, buckle or lace up leather boots of substantial construction are required and must be at least 8 in. high.

7.C.4 Gloves:

Leather gloves are required. No perforated or skeleton gloves are permitted.

7.D MOTORCYCLE CLASS GUIDE:

7.D.1 Frame Classes

P	Production	M	Modified
MPS	Modified Partial Streamlining	A	Altered
APS	Altered Partial Streamlining	SC	Sidecar
S	Streamliner	SCS	Sidecar Streamliner

7.D.2 Engine Displacements:

Permitted engine Sizes are shown in cubic centimeters (cc):

<50, 100, 125, 175, 250, 350, 400, 500, 650, 750, 1000, 1350, 1650, 2000, 3000, 3001+.

Electric sizes are rated by the voltage-of the battery pack (v): **(See 5.I.12)**

7.D.3 Engine size overbore:

To permit minor reconditioning of worn cylinder blocks in classes other than Production, it is permitted to increase cylinder bore diameter .020 in. (.508 mm) beyond that which provides maximum displacement for the class. In all cases, exceeding the overbore size moves the engine to the next higher class.

Vintage OEM engines are allowed +.050 in overbore, see 7.D.4.17.

7.D.4 ENGINE CLASSES:

7.D.4.0 ENGINE CLASSES ALL FALL INTO VARIOUS COMBINATIONS OF INDUCTION METHOD AND FUEL SOURCE DEFINED BELOW:

See 7.B.3.1 & 7.B.3.2

Blown is defined as an engine with a supercharger or turbocharger that pressurizes the intake system above atmospheric pressure.

ENGINE CLASSES FOR PRODUCTION CLASS MOTORCYCLES

7.D.4.1 Production (/P):

Production engines must be the same model as the frame being used and must have STOCK EXTERNAL APPEARANCE. Production motorcycles must use OEM cylinders, heads and crankcases. OEM engine displacement determines class for competition. See Section 7.D.3. Starter must be retained and operable. Carburetors or throttle bodies must be OEM for that model production engine. ALL PRODUCTION ENGINES RUN IN GAS (G) CLASS.

7.D.4.2 Production Blown (/PB):

Production (P), with original brand factory turbo or supercharger required.

7.D.4.3 Production Push Rod (/PP):

As Production (P), but must have pushrod operated valves.

7.D.4.4 Production Twin (/PT):

Same as Production (P) for single and twin cylinder engines only. Pushrod and OHC engines with cylinder angles of 0 – 180 degrees allowed.

7.D.4.5 Production Blown Twin (/PBT):

As above with original brand factory turbo or supercharger required.

7.D.4.6 Production Classic (/PC):

Same as Production (P) for 4-stroke air cooled engines manufactured between 1956 and 1986 inclusively. **NON-OEM CASES AND HEADS ALLOWED SO LONG AS DIMENSIONALLY EQUIVALENT TO OEM.**

7.D.4.7 Production Vintage (/PV):

Same as Production but must have been produced prior to 1956. **NON-OEM CASES AND HEADS ALLOWED SO LONG AS DIMENSIONALLY EQUIVALENT TO OEM.**

7.D.4.8 Production Electric (/PE):

Same as Production Electric Cars. Non-OEM controllers not allowed.

ENGINE CLASSES FOR MODIFIED AND ALTERED MOTORCYCLES

ALTERED (A & APS) MAY RUN ANY ENGINE DESIGN. PRIOR APPROVAL TO BE OBTAINED FOR ALL NON-MOTORCYCLE ENGINES.

7.D.4.9 Blown Gas / Fuel (BG) and (BF):

Same as (G) and (F) respectively with a supercharger or turbocharger required per 7.D.4.0. Water injection is allowed.

7.D.4.11 Push Rod Gas / Fuel (PG) and (PF):

Any motorcycle engine with push rod operated valves as defined below.

The camshaft must be located at least one crankshaft stroke below the OEM cylinder deck position or that utilize OEM pushrod length at least twice the crankshaft stroke. Replacement heads must have the same number of valves as originally produced as a production engine.

7.D.4.12 Pushrod Blown Gas / Fuel (PBG) and (PBF):

Same as (PG) and (PF) above, with a supercharger or turbocharger required; subject to the same limitations as Classes (BG) and (BF) respectively.

7.D.4.13 Twin Gas / Fuel (TG) and (TF):

Any 4-stroke motorcycle engine with 1 or 2 cylinders. Unlimited in design and modification. Pushrod and OHC engines with cylinder angles of 0 – 180 degrees allowed. Subject to the same limitations as (G) and (F) respectively.

7.D.4.14 Twin Blown Gas / Blown Fuel (TBG) and (TBF):

Same as Section (TG) and (TF) above with a supercharger or turbocharger required. Subject to the same limitations as Classes (BG) and (BF) respectively.

7.D.4.15 Classic Gas / Fuel (CG) and (CF):

Any air cooled motorcycle engine manufactured between 1956 and 1986 inclusively. Extensive design and modification of engine allowed. Alteration of cooling fin design, size and placement is allowed. Any system designed to enhance cooling is not permitted. (This includes, but is not limited to water injection, nitrous oxide or water spray systems, radiators, enlarged oil capacity or modified oil systems.)

Fuel delivery may be modified or upgraded but OEM carbureted bikes must remain carbureted. OEM fuel injection may be retained, modified or replaced by carburetors. No non-OEM engine management allowed. One distributor or magneto allowed. Computers are allowed for data collection purposes only.

7.D.4.16 Classic Blown Gas / Fuel (CBG) and (CBF):

Same as (CG) and (CF) above with a supercharger or turbocharger required.

7.D.4.17 Vintage Gas / Fuel (VG) and (VF):

Same as Class G or F, except that the class is limited to engines produced prior to 1956.

Vintage engine modifications are restricted to older technology levels as far as practical. Accordingly, in classes VF, VG, VBF and VBG newer technologies such as EFI, or electronic

reactive ignition systems are not in keeping with the spirit of the Vintage classes and are not allowed. Computers are allowed for data collection purposes only.

A .050 in. overbore is allowed on OEM vintage engines. Flathead engine displacement will be discounted 33 1/3% in determining engine displacement class limits.

7.D.4.18 Vintage Blown Gas / Fuel (VBF) and (VBG):

Same as class VF or VG with a supercharger required. See 7.D.4.0.

7.D.4.19 Electric (E):

Same as class (PE) with unlimited design and modifications allowed.

7.D.4.20 Class Ω / Omega(O):

An engine using a thermodynamic cycle other than Otto, Two Cycle or Diesel. This class includes steam and turbine engines. Entry must comply with all applicable frame class requirements. Entrant must submit power plant details to the technical committee for evaluation at least 45 days prior to the meet.

7.D.5 Allowed Engines Per Classes:

Frame Class	Engine Classes	Max Disp.	Max #of Engines:
P	P, PB, PP, PPB, PT, PBT, PC, PV,PE	3000	1
M, MPS	All	3000	1
A, APS	All	3001+	2
S, SC, SCS	NO VINTAGE, TWIN, CLASSIC	3001+	2

7.E MOTORCYCLE CLASSES



7.E.1 PURE PRODUCTIONS & PRODUCTION MOTORCYCLES

This class is limited to production, street-legal motorcycles of which 50 or more have been produced and which are available for sale to the public through dealers. Motorcycles in this class shall retain all original functionality. The motorcycle must appear identical in all respects to the production model represented including the air box and exhaust system (excluding paint and decals). Any performance modifications must be out of view.

Smoothing, filling, removal of badges etc, or other physical changes are not permitted.

PURE PRODUCTION MUST RUN THE ENGINE CLASS THE BIKE WAS MANUFACTURED IN.

THE ONLY MODIFICATIONS WHICH MAY OR MUST BE MADE ARE:

7.E.1.1 Handlebars:

Any OEM handle bar mounts may be fitted, except handlebars which extend more than 15 in. above, 4 in. in front of, or 4 in. below the OEM handle bar mounts. Controls and switches must remain OEM. See Section 7.B.11.

7.E.1.2 Footrests:

OEM rider footrests must be used. Passenger footrests and brackets shall be removed unless integrated into the frame or used for an additional purpose.

7.E.1.3 Side and center stands:

These may be removed.

7.E.1.4 Air cleaner element, toolbox, and license plate bracket:

Air cleaner and toolbox may be removed. License plate bracket must remain.

7.E.1.5 Number/Class:

See Section 7.B.1.

7.E.1.6 Lighting equipment and instruments:

Reflectors, turn signal lights, and supporting brackets may be removed if not integrated with body fairing parts. Lamps may be rendered inoperative. Adjustable headlights must have the lens mounted in the vertical position. Non-OEM gauges, instruments or controls are not permitted.

7.E.1.7 Fairings, windshields, seats and side panels:

OEM parts for the model must remain on the motorcycle and unaltered.

7.E.1.8 Tires:

See Section 7.B.9.

7.E.1.9 Chain Guard:

See section 7.B.16.

7.E.1.10 Wheel rims:

May be changed if necessary to obtain tires that meet the tire requirements.

7.E.1.11 Suspension height adjustment:

OEM Specification for minimum ground clearance must be met.

7.E.1.12 Sprockets/Pulleys:

Sprockets/pulleys may be changed; OEM size/width must be maintained.

7.E.1.13 Accessories/Options

Any accessory or option available for the make, model and year of the motorcycle is allowed if delivered from the factory with the option installed.



7.F MODIFIED MOTORCYCLES

A: An OEM frame must be used. Steering head angle may be altered, but must remain in its original location. Swing arm length, type and mounting method may be altered. Brackets, braces, mounts, etc. may be moved, modified or removed. Perimeter type frame engine cradle tubes must remain unmodified. Spar-style main frame spars must remain unmodified.

B: This class includes all models and limited models (more than 50).

The requirements for this class include:

A: The engine must be from the same manufacturer as the frame.

B: Classic class requires frames manufactured between 1956-1986 inclusively.

C: A single engine with maximum displacement limited to 3000 cc.

D: Maximum wheelbase of 68".

E: Handlebar grips and rider seating position must be above the top of the rear tire with the rider seated, unless original OEM design.

F: Gas tanks, if not original equipment to the production model, must have a minimum capacity of 5 liters or 1.32 gallons.

G: Conversion ICE to EV allowed so long as all other class rules are met.

Bikes that meet the requirements for the Modified Class by definition cannot run in Altered Class unless modified to meet those class requirements.

7.F.1 Footrests:

Must be ahead of the rear axle by at least by 6 in.

7.F.2 Optional exhaust systems:

Pipes may not extend behind rear edge of rear bodywork.

7.F.3 Number/Class Designation plates:

See Section 7.B.1.

7.F.4 Fenders:

Must resist deflection at speed. Rear portion of rear fender may be removed or fenders made and attached in a workmanship-like manner may be fitted.

7.F.4.1 Front Fenders:

Front fender is optional, and if used must comply with the following: front wheel and tire must be visible for a continuous 180 degrees of their circumference. The front may not extend lower than a horizontal line through the front axle. Perimeter may not be farther than 1.750 in. from the tire tread on non-OEM or modified fenders. The sides of the fender may fair in the fork tubes or sliders, but may not be over 2" wider overall than these parts.

7.F.4.2 Rear Fenders:

Rear fenders shall extend rearward to a point not less than a vertical line drawn through the rear axle. A seat that covers the rear wheel to the vertical line meets the requirement.

7.F.6 Axles:

All axles must be steel alloy, OEM aluminum or Titanium.

7.F.7 Forks:

Must be of sufficient strength. Center hub steering or equivalent is not permitted, unless factory produced for the model.

7.F.8 Brakes:

See section 7.B.10.

7.F.9 Chain Guard:

See section 7.B.16.



53

7.F.11 Modified Class (M):

1. Seat or tail section must conform to Modified Partial Streamliner (MPS).
2. No streamlining is permitted in the Modified class. Streamlining is any devices or objects forward of the rider that has the apparent purpose of limiting or controlling airflow around the motorcycle or rider. Un-modified OEM air inlet scoops, instruments, instrument panels and/or headlights mounted with un-modified OEM mounts in the OEM location are allowed.
4. Round headlight must be between 5½" and 7" OD at the lens surface with a front radius >18 in. The front surface must be within 5 deg. of perpendicular to the ground with the vehicle loaded. Any OEM motorcycle headlight must be installed in its originally intended position.
5. Motorcycles using non-OEM instruments, or OEM instruments not using OEM mounts, must be mounted within an area no farther forward than 6 in. in front of the leading edge of the upper triple clamp nor more than 4 in. above the top of the upper triple clamp nor more than 2 in. below the top of the upper triple clamp nor wider than 1 in. outside of each fork tube.

7.F.12 Modified Partial Streamliner Class (MPS):

OEM Bodywork:

The OEM fairing, bodywork and tail section for the specific production model are allowed without limitation. Fairing and tail section must be mounted in their original relationship to each other.

Replacement non-OEM fairings, bodywork and tail sections that exceed the limits in the section below must be an exact replica of the OEM parts.

Custom or Non-Model Original Bodywork:

No part of the fairing ahead of the front axle may be lower than the top of the front rim at the axle vertical centerline or extend forward of the front edge of the rim. Front fender coverage may not extend lower than a horizontal line through the front axle. There must be no streamlining forward of the front edge of the front rim. There must be no streamlining (other than a seat or tail section) to the rear of a line drawn vertically through the axle of the rear wheel, and the wheel must be visible for the 180 deg. of its circumference to the rear of

such a line. If a streamlined seat or tail section is used it cannot extend further to the rear than 3" from a vertical line at the rear edge of the rear tire or be more than 42 in. from the ground with the rider seated on the bike. It must be possible to see (all of) the rider completely from either side, except the hands and forearms; as viewed from directly above it must be possible to see all of the rider except the hands, forearms, and legs. Fairings or bodywork must have a minimum of 3 mounting points. Egress demonstration may be required.



7.G ALTERED MOTORCYCLES

The Altered class is INTENDED for purpose-built, modified frame, Full APS Fairing, and race motorcycles. This class includes factory produced road racing or other racing "works" models. A specially constructed or "Altered" frame is unlimited in design, except for the class requirement of this section.

This class may have either a full APS fairing or two of the following:

- Two engines
- Unlimited engine displacement.
- Seat base lower than top of rear tire with the rider seated on the bike
- A fuel tank of any size
- Design items not permitted in the Modified Production class
- Center hub steering

7.G.1 Footrests:

Must be provided and the location is optional.

7.G.2 Optional exhaust systems:

Exhaust pipes may not extend beyond the rear edge of the rear bodywork.

7.G.3 Number/Class Designation plates:

See Section 7.B.1.

7.G.4 Fenders:

See fenders in Section 7.F.4.

7.G.5 Gas tank:

Must be mounted and constructed in a workmanship-like manner.

7.G.6 Wheels:

Must have a minimum nominal rim diameter of 15 in.

7.G.7 Brakes:

See section 7.B.10.

7.G.8 Chain guard:

See Section 7.B.16.

7.G.9 Engine:

Any single or dual combination of engines is permitted. No more than two engines are permitted. Maximum total engine displacement for the motorcycle is unlimited.



7.G.10 Altered Class (A):

- A: No streamlining is permitted in Altered class. Streamlining is defined as any devices or objects forward of the rider that have the apparent effect of directing, limiting, or controlling airflow around the cycle or rider.
- B: Seat or tail section must conform to partial streamlining rules. (Below)
- C: Round headlight must be between 5½" and 7" OD at the lens surface with a front radius >18 in. The front surface must be within 5 deg. of perpendicular to the ground with the vehicle loaded. Any OEM motorcycle headlight must be installed in its originally intended position.
- D: Un-modified OEM air inlet scoops, OEM instruments, and/or OEM instrument panels mounted with un-modified OEM mounts in the OEM location are allowed.



55

7.G.11 Altered Partial Streamliner Class (APS):

If a streamlined seat or tail section is used it cannot extend farther to the rear than a maximum of 10 in. beyond the rear edge of the rear tire or 1/3 of the wheelbase, whichever is less. Seat/tail shall be between 4"-40" off the ground with the rider seated.

Rider must be visible from both sides, except hands and forearms. Viewed from above, rider must be visible except the hands, forearms, and legs. Transparent material are forbidden. Egress demonstration may be required.

Fairings or bodywork must have a minimum of 3 mounting points. No part of the fairing ahead of the front axle may be lower than the top of the front rim at the axle vertical centerline or be forward of the front edge of the rim. There must be no streamlining forward of the front edge of the front rim.



7.H STREAMLINER (S):

A Streamliner is a motorcycle designed so that it is not possible to see the complete rider in the normal riding position from either side or above. Wheelbase is unlimited and must make a single track. Power must be transmitted through the rear wheel only. Engine Specifications shall be the same as Altered. Steering must be done with the front wheel.

7.H.1 Sealed Firewall:

There must be at least one sealed firewall between the rider and engine/fuel compartment(s) as well as adequate drains in engine/fuel compartment(s). All linkage and controls that pass

through the firewall(s) must go through the upper half to avoid fuel seepage into the rider compartment.

7.H.2 Fire Extinguishing System:

Streamliners must have a fire extinguisher system directed to the engine/fuel compartment. If an automatic heat sensing control is used, a manual control must also be fitted. Refer to Section 3.Q for other requirements.

7.H.3 Driver/Rider Suit:

A complete, approved driver/rider suit conforming to SFI specification 3.2A/15 or SFI/5 with fire proof underwear under 200mph is REQUIRED. Gloves and boots must be SFI specification 3.3/5 rating. A SFI specification 3.3 head sock must be worn under the helmet.

7.H.4 Roll Cage:

Shall be fitted in the rider's compartment and completely surround the rider. Minimum diameter is 1-1/4 in. with .090 in. steel tubing. No galvanized, black iron or threaded fittings permitted. The design shall incorporate the following features as a minimum: Two (2) roll bars, (one forward and one after the rider's head), which must be tied together and capped with a steel plate .090 in. thick. The cap must cover the upper 140 deg. of the rider's head. The roll bar must be braced with a tube of the same dimensions on each side. Rider head movement must be limited to no more than 2 in. to each side, top, or rear, with rider's head in the normal position. Roll cage padding meeting SFI specification 45.1 for round tube roll cage padding and SFI specification 45.3 for flat roll cage padding is required in the vicinity of the driver's helmet.

Forward Movement: Vehicle shall have an engineered and tested for SFI spec 38.1 type head and neck restraint system.

Refer to Section 3.A & B for design explanations.

7.H.5 Seat Belts and Limb Restraints:

Seat belt harness with shoulder, lap, crotch straps and limb restraints from the wrist to the central harness buckle required. see Section 3.D.

7.H.6 Rider Compartment:

The rider compartment must be free from sharp edges, brackets, etc., within close proximity to the rider. A rigid inner liner must be provided to retain legs within roll cage structure. The rider compartment must be equipped with a fresh air intake or breathing system. All air breathing and cooling that supply air to the driver must have fire retardant protection on the hoses.

The seat shall be constructed of a metal or alloy sufficient to retain the driver under high G loading. No plastic or fiberglass seats allowed.

Secondary flooring, metal sheeting in the driver's compartment for the purpose of retaining the rider and appendages in the event of step pan or belly pan tear away must be added. See Section 3.G.

7.H.7 Windshields:

Must be of shatter-resistant plastic and provide 120 degrees of forward vision.

7.H.8 Fuel Shutoff:

A remote fuel shutoff to disable pump operation that can be actuated from the rider compartment must be fitted. All electric fuel pumps shall have an inertial shutoff switch in the circuit to disable pump operation.

7.H.9 Fender:

A bulkhead or fender must be fitted around any tire within the rider compartment. The fender must be metallic or covered with a ballistic shield.

7.H.10 Canopy:

If used, the rider must be able to exit without assistance whether the machine is upright or on its side. Rider compartment cover or hatch cover must have a release mechanism allowing it to be opened quickly without tools from the inside and the outside the vehicle. The latch must be clearly marked on the outside with directions for opening. The canopy must be closed in competition. Canopy shall not be attached to the steering mechanism.

7.H.11 Tires and Wheels:

Tire and wheel sizes are unlimited. Tires must meet the speed rating as shown in Section 7.B.9. manufactured for racing or reinforced per Section 2.G.

7.H.13 Parachute:

A parachute is required. Over 250 MPH, 2 are required, one high speed and one low speed. An automatic mechanisms shall be installed to actuate when the machine is laid over 50 deg. on enclosed tail, and 80 deg. on open tail. A deployment demonstration is required. Non-manual parachute releases must have a manual release as a backup.

7.H.14 Steering:

Steering systems shall be direct gear or link type. The handlebars and linkage shall have adequate clearance, sufficient strength, and the mounting shall have sufficient support. All moving parts shall operate freely without play.

Steering system spherical ends (i.e., Heim) shall not be made of aluminum and shall have washers with a larger OD than the Heim (solid type Heim joints are required). All bolts must be at least grade 5. For vehicles with long steering shafts the shaft shall be collapsible or have a secondary stop.

7.H.15 Brakes:

All Streamliners must be equipped with a front and rear wheel brake as required, see section 7.B.10.

7.H.16 Number/Class Designation:

Streamliners must have a minimum number/letter area of 10 in. x 12 in. on both sides of the body.

7.H.17 Tanks:

Fuel tank, oil tank, and battery (unless sealed in an acid spill-proof box, Section 7.H.20) must be separated from the driver by a firewall. No fuel lines may be routed through the rider compartment.

7.H.18 Engine:

Any single or dual engines permitted. Maximum displacement is unlimited.

7.H.19 Stabilizer Wheels/Skids:

Stabilizer outriggers are required and must have a positive lock in the up and down positions. Outriggers are to be locked in a up position as soon as the motorcycle becomes stable. Skids are allowed with prior approval.

7.H.20 Batteries:

All batteries shall be properly secured with metal framework and fasteners. Batteries may be mounted in the driver's compartment if sealed in a spill-proof box. Streamliners must be equipped with a visible and clearly marked main battery disconnect switch.

7.H.22 Chain/Belt Guard:

Guards are required to prevent a failed chain or belt from damaging fuel, oil, coolant or hydraulic lines.



7.I SIDECAR CLASS (SC):

A sidecar is a three-wheel vehicle leaving two tracks with only the rear-most wheel driving. The front and rear tires shall leave a single track. All rules are as Modified or Altered except those pertaining specifically to the sidecar.

7.I.1 Driver Location: The rider shall operate the sidecar outfit with motorcycle type handlebars from a position which places his centerline between the front and rear drive treads. The rider must be visible from the hips to the shoulders from the side view and be able to exit the outfit without restriction, unless in compliance with enclosed streamliner rules.

7.I.2 Passenger:

Passenger(s) are not allowed.

7.I.3 Sidecar Mounting:

Sidecar may be located on either side. All mounting brackets and rigid bar fittings must have adequate depth of engagement, rigidity, and security. All attaching fasteners must be safety wired or otherwise secured by verifiable means.

7.I.4 Track:

No less than 32".

7.I.5 Wheelbase:

No greater than 110".

7.I.6 Wheel size:

The sidecar wheel rim may be no less than 5 in. nominal diameter. No size restriction on streamliners.

7.I.7 Wheel cover:

The inside of the sidecar wheel must be covered.

7.I.8 Sidecar Construction

The platform must be able to accommodate a forward-facing, kneeling passenger of 5' 7", 170 lbs. It must have a rectangular shape with minimum dimension of 12" x 32". The 32" dimension shall be parallel to the wheelbase.

7.I.9 Sidecar Wheel Loading

Sidecar wheel must be loaded with secure ballast to assure stability. A minimum of 10% of the rig weight is required to be on the sidecar.

7.J Sidecar Streamliner (SCS):

This is the ultimate sidecar land speed vehicle. Innovation in design is encouraged. Must meet all sidecar requirements and two-wheel streamliner requirements, except Section 7.H.19. Track requirements must conform to Sections 7.I.7 and 7.I.11. No wheelbase restriction for streamliners.

58

7.K Electric Motorcycles

The LTA, in cooperation the NEDRA (National Electric Drag Racing Association) has developed EV motor classes to allow for a compilation of EV land speed records from around the globe. NEDRA rules are used to govern Battery and Motor Specifications. All other vehicle requirements fall under LTA Rules.

NEDRA Class Validation:

Electric vehicles will compete in an appropriate LTA class for LTA records.

The EV Technical Director will certify the NEDRA class for their records.

Electric Power Class Designation:

Electric power shall be designated in the LTA records as a fuel type: i.e. M/E-G = Modified/Electric-100 volt.

7.K.1 Motor

A: Electric motor(s) only permitted.

B: Exposed-motor motorcycles with open frame, vented, or brush replacement window motors must install a motor shield, minimum 0.024-inch steel or 0.032-inch aluminum, or 0.120-inch Lexan.

7.K.2 Batteries

A: Must be securely mounted and protected from accident damage.

B: Sealed boxes must be vented away from the driver and racing surface.

C: Wet, (free liquid) batteries are not allowed.

D: Each battery or battery pack must be secured with bolts and straps commensurate with the size and weight of the battery. See Sec 5.I.7.

7.K.3 Electrical Wiring

See Section 5.I

7.K.4 Fusing of Batteries

See Section 5.I

7.K.5 Recharging

See Section 5.I

7.K.6 Ignition

See Section 5.I

7.K.7 Master Cutoff

See Section 5.I

Loring Timing Association Official Motorcycle Records May 17, 2023

EH #	DATE	DRIVER	TEAM	1.0	CLASS	1.5	VEH #	DRIVER	TEAM	DATE
OVERHEAD CAM CATEGORY										
PURE PRODUCTION										
1984	07/19	ROBERT WILLIAMS	WILLIAMS RACING	66.141	PP/P-125/4	67.664	1984	ROBERT WILLIAMS	WILLIAMS RACING	07/19
9114	07/21	PAUL ROBERTS	TEAM PREHISTORIC	108.338	PP/P-250/4	108.023	9114	STARBUCK ROBERTS	TEAM PREHISTORIC	07/21
88	09/20	TOM SCHAEFER	MYLAWYERTOM.COM	102.301	PP/P-350/4	103.046	88	TOM SCHAEFER	MYLAWYERTOM.COM	09/20
119	09/20	VINCE CORTER	LIFE GOES ON	124.560	PP/P-400/4	125.416	119	VINCE CORTER	LIFE GOES ON	09/20
636	09/20	ROBERT WILLIAMS	WILLIAMS RACING	162.908	PP/P-650/4	164.233	636	ROBERT WILLIAMS	WILLIAMS RACING	09/20
607	09/20	ROBERT WILLIAMS	WILLIAMS RACING	191.271	PP/P-1000/4	191.053	607	ROBERT WILLIAMS	WILLIAMS RACING	09/20
L122	09/20	JOSHUA BATE	MOSQUITO CONTROL RACING	174.768	PP/P-1350/4	178.891	L122	JOSHUA BATE	MOSQUITO CONTROL RACING	09/20
183	09/20	MARK DELUCA	FORSTALL/KNECUM/DELUCA	208.381	PP/P-1650/4	215.663	183	MARK DELUCA	FORSTALL/KNECUM/DELUCA	09/20
PRODUCTION										
1984	09/20	ROBERT WILLIAMS	WILLIAMS RACING	67.923	P/P-125/4	68.249	1984	ROBERT WILLIAMS	WILLIAMS RACING	09/20
9114	07/19	DEVRA ROBERTS	TEAM PREHISTORIC	102.465	P/P-250/4	107.862	9173	RICHARD LORENSEN	RAZEE MOTORCYCLE CENTER	07/11
88	09/20	TOM SCHAEFER	MYLAWYERTOM.COM	102.635	P/P-350/4	106.557	88	TOM SCHAEFER	MYLAWYERTOM.COM	09/20
88	09/20	TOM SCHAEFER	MYLAWYERTOM.COM	110.596	P/P-350/4	111.592	88	TOM SCHAEFER	MYLAWYERTOM.COM	09/20
119	09/20	VINCE CORTER	LIFE GOES ON	119.503	P/P-400/4	121.682	119	VINCE CORTER	LIFE GOES ON	09/20
88	09/20	TOM SCHAEFER	MYLAWYERTOM.COM	110.704	P/P-400/4	111.343	88	TOM SCHAEFER	MYLAWYERTOM.COM	09/20
					P/P-500/4	127.213	9102	MILTON PAUL	MP RACING	08/10
88	09/20	TOM SCHAEFER	MYLAWYERTOM.COM	101.732	P/P-500/4	101.760	88	TOM SCHAEFER	MYLAWYERTOM.COM	09/20
636	09/20	ROBERT WILLIAMS	WILLIAMS RACING	166.933	P/P-650/4	168.683	636	ROBERT WILLIAMS	WILLIAMS RACING	09/20
88	09/20	TOM SCHAEFER	MYLAWYERTOM.COM	102.251	P/P-650/4	100.815	88	TOM SCHAEFER	MYLAWYERTOM.COM	09/20
636	09/20	ROBERT WILLIAMS	WILLIAMS RACING	164.036	P/P-750/4	165.415	636	ROBERT WILLIAMS	WILLIAMS RACING	09/20
88	09/20	TOM SCHAEFER	MYLAWYERTOM.COM	101.692	P/P-750/4	104.456	88	TOM SCHAEFER	MYLAWYERTOM.COM	09/20
L100	09/17	GILLES CHIASSON	GNA RACING	203.331	P/P-1000/4	207.230	L100	GILLES CHIASSON	GNA RACING	09/17
1200	09/18	KIRK LEVONIAN	LEVONIAN RACING	209.144	P/P-1000/4	213.917	1200	KIRK LEVONIAN	LEVONIAN RACING	09/18
184	07/21	STEVE KNECUM	FORSTALL/KNECUM RACING	205.767	P/P-1350/4	211.079	9290	RANSOM HOLBROOK	HOLBROOK SHO	08/09
1692	09/20	TOM SCHAEFER	MYLAWYERTOM.COM	171.030	P/P-1350/4	171.326	1692	TOM SCHAEFER	MYLAWYERTOM.COM	09/20
9819	07/19	FRED GIAIMO	AMERICAN MACHINE/NANCY RACI	212.276	P/P-1650/4	217.709	183	MARK DELUCA	FORSTALL/DELUCA RACING	07/21
1692	09/20	TOM SCHAEFER	MYLAWYERTOM.COM	171.330	P/P-1650/4	172.615	1692	TOM SCHAEFER	MYLAWYERTOM.COM	09/20
9382	09/17	STEVE KNECUM	KNECUM/FORSTALL RACING	217.670	P/P-2000/4	220.355	9382	STEVE KNECUM	KNECUM/FORSTALL RACING	09/17
1692	09/20	TOM SCHAEFER	MYLAWYERTOM.COM	172.003	P/P-2000/4	171.461	1692	TOM SCHAEFER	MYLAWYERTOM.COM	09/20
9819	07/18	FRED GIAIMO	AMERICAN MACHINE/NANCY	213.535	P/P-3000/4	218.905	9819	FRED GIAIMO	AMERICAN MACHINE/NANCY	07/18
1692	09/20	TOM SCHAEFER	MYLAWYERTOM.COM	170.887	P/P-3000/4	173.399	1692	TOM SCHAEFER	MYLAWYERTOM.COM	09/20
MODIFIED										
L050	08/14	RALPHIE NAVARRO	SUPER GROM RACING	71.224	M/G-125/4	72.704	L050	RALPHIE NAVARRO	SUPER GROM RACING	08/14
					M/G-175/4	64.409	9389	TOM CROMPTON	KRYPTON RACING	08/10
L194	09/18	CHUCK SIM	SUBATOMIC RACING	101.450	M/F-175/4	48.871	9389	TOM CROMPTON	KRYPTON RACING	07/11
9635	09/15	GREG NEAL	TLN MOTORSPORTS	99.249	M/G-250/4	103.595	L194	CHUCK SIM	SUBATOMIC RACING	09/18
					M/F-250/4	99.255	9635	GREG NEAL	TLN MOTORSPORTS	09/15

VEH #	DATE	DRIVER	TEAM	1.0	CLASS	VEH #	DRIVER	TEAM	DATE
9635	09/15	GREG NEAL	TLN MOTORSPORTS	98.550	M/BG-250/4	98.589	GREG NEAL	TLN MOTORSPORTS	09/15
9635	09/15	GREG NEAL	TLN MOTORSPORTS	99.070	M/BF-250/4	99.312	GREG NEAL	TLN MOTORSPORTS	09/15
88	09/20	TOM SCHAEFER	MYLAWYERTOM.COM	99.083	M/G-350/4	25.915	TOM SCHAEFER	MYLAWYERTOM.COM	09/20
88	09/20	TOM SCHAEFER	MYLAWYERTOM.COM	100.474	M/F-350/4	101.398	TOM SCHAEFER	MYLAWYERTOM.COM	09/20
88	09/20	TOM SCHAEFER	MYLAWYERTOM.COM	99.774	M/BG-350/4	100.200	TOM SCHAEFER	MYLAWYERTOM.COM	09/20
88	09/20	TOM SCHAEFER	MYLAWYERTOM.COM	98.688	M/BF-350/4	99.591	TOM SCHAEFER	MYLAWYERTOM.COM	09/20
1194	09/21	CHUCK SIM	SUBATOMIC RACING	102.518	M/BG-400/4	102.229	CHUCK SIM	SUBATOMIC RACING	09/21
88	09/20	TOM SCHAEFER	MYLAWYERTOM.COM	101.074	M/F-400/4	101.455	TOM SCHAEFER	MYLAWYERTOM.COM	09/20
88	09/20	TOM SCHAEFER	MYLAWYERTOM.COM	98.696	M/BG-400/4	100.006	TOM SCHAEFER	MYLAWYERTOM.COM	09/20
88	09/20	TOM SCHAEFER	MYLAWYERTOM.COM	99.866	M/BF-400/4	100.564	TOM SCHAEFER	MYLAWYERTOM.COM	09/20
9474	07/13	WENDELL ALLEN	ALLEN RACING	117.824	M/G-500/4	120.260	WENDELL ALLEN	ALLEN RACING	07/13
88	09/20	TOM SCHAEFER	MYLAWYERTOM.COM	100.895	M/F-500/4	103.033	TOM SCHAEFER	MYLAWYERTOM.COM	09/20
9877	07/18	JOE HEFFERNAN	FOIL HAT RACING	157.299	M/BG-500/4	167.209	JOE HEFFERNAN	FOIL HAT RACING	07/18
9877	07/18	CHUCK JAY	FOIL HAT RACING	162.285	M/BF-500/4	169.546	CHUCK JAY	FOIL HAT RACING	07/18
119	09/15	GREG NEAL	TLN MOTORSPORTS	169.620	M/VG-500/4	94.239	DAVID DUNFEY	DAVID DUNFEY	08/09
119	09/15	GREG NEAL	TLN MOTORSPORTS	171.539	M/F-650/4	170.572	GREG NEAL	TLN MOTORSPORTS	09/15
119	09/15	GREG NEAL	TLN MOTORSPORTS	170.614	M/BG-650/4	171.984	JOSEPH DALY	FAIRWAY MOTORSPORTS	08/14
119	09/15	GREG NEAL	TLN MOTORSPORTS	168.760	M/BF-650/4	166.624	GREG NEAL	TLN MOTORSPORTS	09/15
119	09/15	GREG NEAL	TLN MOTORSPORTS	169.361	M/F-750/4	170.346	GREG NEAL	TLN MOTORSPORTS	09/15
119	09/15	GREG NEAL	TLN MOTORSPORTS	173.166	M/F-750/4	172.698	GREG NEAL	TLN MOTORSPORTS	09/15
119	09/15	GREG NEAL	TLN MOTORSPORTS	171.894	M/BG-750/4	171.520	GREG NEAL	TLN MOTORSPORTS	09/15
119	09/15	GREG NEAL	TLN MOTORSPORTS	170.516	M/BF-750/4	165.937	GREG NEAL	TLN MOTORSPORTS	09/15
489	09/18	KRIS POULIN	#TEAM469	184.742	M/G-1000/4	187.072	KRIS POULIN	#TEAM469	09/18
9416	09/17	CLIFF DALY	FAIRWAY MOTORSPORTS	197.185	M/F-1000/4	196.150	CLIFF DALY	FAIRWAY MOTORSPORTS	07/16
737	07/22	AARON KNIGHT	KNIGHTHAWK MS	192.475	M/BG-1000/4	220.647	DEAN SABATINELLI	SABATINELLI RSK-FAST	08/09
1004	08/14	ALEX MERRELL	KNIGHTHAWK MS	197.486	M/BF-1000/4	197.644	AARON KNIGHT	KNIGHTHAWK MS	07/22
1004	08/14	ALEX MERRELL	MERRELL RACING	200.869	M/G-1350/4	199.371	ALEX MERRELL	MERRELL RACING	08/14
1004	07/13	ALEX MERRELL	MERRELL RACING	198.644	M/F-1350/4	199.696	ALEX MERRELL	MERRELL RACING	07/13
9727	08/13	JOHN UBERMUTH	UBERMUTH RACING	171.512	M/BG-1350/4	172.344	JOHN UBERMUTH	UBERMUTH RACING	08/13
265	07/19	SHANE STUBBS	TREDWAY STUBBS RACING	265.291	M/BF-1350/4	208.768	DEREK TOTI	TNT RACING	07/16
320	07/22	PHILLIP JOHNSON	TEAM TURBO TIGER	169.803	M/VF-1350/4	96.074	BRIAN HAENLEIN	BRIAN HAENLEIN RACING	07/10
265	07/19	SHANE STUBBS	TREDWAY STUBBS RACING	261.086	M/F-1650/4	202.821	ROY BROOKS	BROOKS RACING	08/09
7112	07/17	LANCE FRIEDMAN	OXCART RACING	172.485	M/BF-1650/4	202.853	ROY BROOKS	BROOKS RACING	08/10
338	07/22	CHRIS BURNS	TEAM TURBO TIGER	216.884	M/BF-2000/4	216.199	MARK GORDON	GORDON RACING	09/12
7112	07/17	LANCE FRIEDMAN	OXCART RACING	176.243	M/F-3000/4	178.779	LANCE FRIEDMAN	OXCART RACING	07/22
9647	09/12	MARK GORDON	GORDON RACING	208.297	M/BF-3000/4	222.699	MARK GORDON	GORDON RACING	09/12
419	07/18	JOE ROBINSON	I NEED COFFEE	71.889	MPS/G-100/4	72.914	JOE ROBINSON	I NEED COFFEE	07/18
419	07/18	MELONIE AURAND	I NEED COFFEE	74.201	MPS/G-125/4	75.018	MELONIE AURAND	I NEED COFFEE	07/18
					MPS/G-175/4	67.391	TOM CROMPTON	KRYPTON RACING	07/11
					MPS/F-175/4	67.333	TOM CROMPTON	KRYPTON RACING	08/10

MODIFIED PARTIAL STREAMLINER

VEH #	DATE	DRIVER	TEAM	CLASS	1.0	1.5	VEH #	DRIVER	TEAM	DATE
4494	07/21	JAMIE DALY	FAIRWAY MOTORSPORTS	MPS/G-250/4	106.294	107.168	4494	JAMIE DALY	FAIRWAY MOTORSPORTS	07/21
904	09/18	MELONIE AURAND	I NEED COFFEE	MPS/F-250/4	105.298	108.028	904	DAVE AURAND	I NEED COFFEE	09/18
9635	09/15	GREG NEAL	TLN MOTORSPORTS	MPS/BF-250/4	104.699	105.647	9635	GREG NEAL	TLN MOTORSPORTS	09/15
L155	07/15	RACHEAL JOHNSON	WARP 12 RACING	MPS/G-350/4	114.324	116.314	L155	RACHEAL JOHNSON	WARP 12 RACING	07/15
L155	07/15	RACHEAL JOHNSON	WARP 12 RACING	MPS/F-350/4	115.774	117.442	L155	RACHEAL JOHNSON	WARP 12 RACING	07/15
L155	07/15	RACHEAL JOHNSON	WARP 12 RACING	MPS/BG-350/4	114.839	116.553	L155	RACHEAL JOHNSON	WARP 12 RACING	07/15
L155	07/15	RACHEAL JOHNSON	WARP 12 RACING	MPS/BF-350/4	115.561	115.865	L155	RACHEAL JOHNSON	WARP 12 RACING	07/15
L155	07/15	RACHEAL JOHNSON	WARP 12 RACING	MPS/G-400/4	112.367	112.716	L155	RACHEAL JOHNSON	WARP 12 RACING	07/15
L155	07/15	RACHEAL JOHNSON	WARP 12 RACING	MPS/F-400/4	110.675	111.505	L155	RACHEAL JOHNSON	WARP 12 RACING	07/15
L155	07/15	RACHEAL JOHNSON	WARP 12 RACING	MPS/BG-400/4	112.901	112.858	L155	RACHEAL JOHNSON	WARP 12 RACING	07/15
L155	07/15	RACHEAL JOHNSON	WARP 12 RACING	MPS/BF-400/4	111.656	112.003	L155	RACHEAL JOHNSON	WARP 12 RACING	07/15
9474	07/15	WENDELL ALLEN	ALLEN RACING	MPS/G-500/4	132.179	131.953	9474	WENDELL ALLEN	MP RACING	07/16
9877	07/18	JOE HEFFERNAN	FOIL HAT RACING	MPS/BG-500/4	178.060	185.832	9877	JOE HEFFERNAN	FOIL HAT RACING	07/18
9877	07/16	CHUCK JAY	FOIL HAT RACING	MPS/BF-500/4	181.804	170.756	9877	CHUCK JAY	FOIL HAT RACING	07/16
9444	07/16	GREG NEAL	TLN MOTORSPORTS	MPS/G-650/4	190.176	195.636	9444	GREG NEAL	TLN MOTORSPORTS	07/16
9444	07/16	GREG NEAL	TLN MOTORSPORTS	MPS/F-650/4	190.947	194.597	9444	GREG NEAL	TLN MOTORSPORTS	07/16
L119	07/15	GREG NEAL	TLN MOTORSPORTS	MPS/BG-650/4	187.424	190.599	L119	GREG NEAL	TLN MOTORSPORTS	07/15
L119	07/15	GREG NEAL	TLN MOTORSPORTS	MPS/BF-650/4	188.847	191.583	L119	GREG NEAL	TLN MOTORSPORTS	07/15
L119	05/16	GREG NEAL	TLN MOTORSPORTS	MPS/G-750/4	188.895	192.690	L119	GREG NEAL	TLN MOTORSPORTS	05/16
L119	05/16	GREG NEAL	TLN MOTORSPORTS	MPS/F-750/4	189.808	191.941	L119	GREG NEAL	TLN MOTORSPORTS	05/16
L119	07/15	GREG NEAL	TLN MOTORSPORTS	MPS/BG-750/4	187.639	189.053	L119	GREG NEAL	TLN MOTORSPORTS	07/15
L119	05/16	GREG NEAL	TLN MOTORSPORTS	MPS/BF-750/4	187.771	192.284	L119	GREG NEAL	TLN MOTORSPORTS	05/16
469	09/20	KRIS POULIN	#TEAM469	MPS/G-1000/4	208.030	200.461	469	KRIS POULIN	#TEAM469	09/20
9731	09/12	GREG NEAL	TLN MOTORSPORTS	MPS/F-1000/4	204.792	206.543	9731	GREG NEAL	TLN MOTORSPORTS	09/12
1400	07/18	ADAM BURROWS	CMP/BROCKS	MPS/BG-1000/4	233.636	245.345	1400	DEAN SABATINELLI	SABATINELLI RSK-FAST	08/09
9280	09/12	DON HASS	HASS-SERAFINI RACING	MPS/BF-1000/4	234.632	239.852	9280	DON HASS	LAST MINUTE RACING	08/09
4473	07/12	BRENDA SUE CARVER	BRENDA SUE CARVER	MPS/G-1350/4	216.765	221.572	4473	BRENDA SUE CARVER	BRENDA SUE CARVER	07/12
9486	07/16	SCOTT DAVIS	HUNTER RACING	MPS/F-1350/4	215.124	229.621	9486	ALI ABABAKR	RNR CYCLES	08/09
2095	07/15	REVON SCOTT	DBMOTO	MPS/BG-1350/4	239.011	257.813	2095	BILL WARNER	WILD BROS RACING	08/09
38	07/18	EDWARD FOY	FOY BROTHERS RACING	MPS/BF-1350/4	236.307	273.356	38	BILL WARNER	WARNER/FORSTALL RACING	07/10
9619	09/20	FRED GIAMIO	AMERICAN MACHINE/NANCY RACI	MPS/G-1650/4	214.159	237.742	9619	MARK DELUCA	FORSTALL/DELUCA/KNECUM	08/09
320	07/22	PHILLIP JOHNSON	TEAM TURBO TIGER	MPS/F-1650/4	215.060	235.777	320	COLT BATEMAN	TEAM FAT ASS	07/22
153	07/22	CHRIS BURNS	KNIGHTHAWK MS	MPS/BG-1650/4	235.925	239.450	153	CHRIS BURNS	KNIGHTHAWK MS	07/22
2095	07/16	REVON SCOTT	DBMOTO	MPS/BF-1650/4	245.112	260.990	2095	SHANE STUBBS	SCOTT GUTHRIE RACING	08/09
L118	07/17	RANSOM HOLBROOK	H&H RACING	MPS/G-2000/4	215.066	223.214	L118	RANSOM HOLBROOK	H&H RACING	07/17
473	07/15	FRED VANCE	VANCE& FORSTALL	MPS/F-2000/4	227.647	234.855	473	FRED VANCE	VANCE& FORSTALL	07/15
L1001	05/16	HUSSAIN ALSOWAIGH	ALSOWAIGH RACING	MPS/BG-2000/4	255.624	265.181	L1001	SHANE STUBBS	SCOTT GUTHRIE RACING	08/09
214	07/15	RYAN OSTERGARD	OSTERGARD RACING	MPS/BF-2000/4	246.892	253.951	214	RYAN OSTERGARD	OSTERGARD RACING	07/15
9619	07/21	FRED GIAMIO	AMERICAN MACHINE/NANCY	MPS/G-3000/4	215.489	225.301	9619	MIKE BRAKEL	MIKE BRAKEL RACING	07/21
L173	05/16	BEN KNIGHT	BEN KNIGHT RACING	MPS/F-3000/4	227.358	235.189	L173	STEVE KNECUM	FORSTALL/DELUCA/KNECUM	08/09
2095	05/16	REVON SCOTT	DBMOTO	MPS/BG-3000/4	251.816	239.242	2095	EDWARD PETROZZI	2 BAR RACING	09/16
9532	08/14	EDWARD PETROZZI	2 BAR RACING	MPS/BF-3000/4	245.695	250.274	9532	EDWARD PETROZZI	2 BAR RACING	08/14

62

VEH #	DATE ALTERED	DRIVER	TEAM	CLASS	1.0	VEH #	DRIVER	TEAM	DATE
9635	09/15	GREG NEAL	TLN MOTORSPORTS	A/G-250/4	99.060	9635	GREG NEAL	TLN MOTORSPORTS	09/15
9635	09/15	GREG NEAL	TLN MOTORSPORTS	A/F-250/4	98.920	9635	GREG NEAL	TLN MOTORSPORTS	09/15
9635	09/15	GREG NEAL	TLN MOTORSPORTS	A/BG-250/4	99.715	9635	GREG NEAL	TLN MOTORSPORTS	09/15
1908	07/16	JESSE MICHAUD	FAIRWAY MOTORSPORTS	A/BF-250/4	99.219	9635	GREG NEAL	FAIRWAY MOTORSPORTS	07/16
1908	07/16	JOSEPH DALY	FAIRWAY MOTORSPORTS	A/F-400/4	102.520	1908	FRANK JOHN	FAIRWAY MOTORSPORTS	07/16
9444	07/16	GREG NEAL	TLN MOTORSPORTS	A/BF-400/4	104.733	1908	JOSEPH DALY	FAIRWAY MOTORSPORTS	07/16
9444	07/16	GREG NEAL	TLN MOTORSPORTS	A/G-650/4	168.199	9444	GREG NEAL	TLN MOTORSPORTS	07/16
9444	07/16	GREG NEAL	TLN MOTORSPORTS	A/F-650/4	169.193	765	CLIFF DALY	FAIRWAY MOTORSPORTS	07/16
336	07/17	ETIENNE CREVIER	G-FORCE	A/BG-650/4	168.777	9444	GREG NEAL	TLN MOTORSPORTS	07/16
889	09/15	RAY ROBERT	MARK THE MECHANIC RACING	A/BV-650/4	169.292	765	JOSEPH DALY	FAIRWAY MOTORSPORTS	08/14
9444	09/16	GREG NEAL	TLN MOTORSPORTS	A/G-750/4	70.113	889	RAY ROBERT	TLN MOTORSPORTS	09/15
765	08/14	CLIFF DALY	FAIRWAY MOTORSPORTS	A/F-750/4	166.175	9444	GREG NEAL	FAIRWAY MOTORSPORTS	09/16
765	07/17	JOSEPH DALY	FAIRWAY MOTORSPORTS	A/BG-750/4	169.478	765	CLIFF DALY	FAIRWAY MOTORSPORTS	08/14
765	07/17	CLIFF DALY	FAIRWAY MOTORSPORTS	A/BF-750/4	200.931	765	JOSEPH DALY	FAIRWAY MOTORSPORTS	07/17
9516	07/19	CLIFF DALY	FAIRWAY MOTORSPORTS	A/G-1000/4	204.289	765	CLIFF DALY	FAIRWAY MOTORSPORTS	07/19
9516	09/15	JOE DALY	FAIRWAY MOTORSPORTS	A/F-1000/4	177.442	9516	CLIFF DALY	FAIRWAY MOTORSPORTS	07/19
9444	09/16	GREG NEAL	TLN MOTORSPORTS	A/BG-1000/4	170.348	9516	JOE DALY	FAIRWAY MOTORSPORTS	07/15
1315	07/16	MARK DOTSON	MARK THE MECHANIC RACING	A/BG-1000/4	199.212	765	JOSEPH DALY	FAIRWAY MOTORSPORTS	09/16
473	07/12	FRED VANCE	VANCE& FORSTALL	A/G-1350/4	168.553	9444	GREG NEAL	TLN MOTORSPORTS	07/16
9444	09/16	GREG NEAL	TLN MOTORSPORTS	A/BG-1350/4	196.714	1315	MARK DOTSON	MARK THE MECHANIC RACING	09/16
9444	09/16	GREG NEAL	TLN MOTORSPORTS	A/BF-1350/4	204.878	473	FRED VANCE	VANCE& FORSTALL	07/12
182	09/20	STEVE KNECUM	FORSTALL/KNECUM/DELUCA	A/BG-1650/4	168.491	1110	DEAN SABATINELLI	FORSTALL/KNECUM/DELUCA	07/10
182	07/21	DEAN SABATINELLI	FORSTALL/SABATINELLI/KNECUM	A/F-1650/4	166.224	2183	STEVE KNECUM	FORSTALL/KNECUM/DELUCA	08/09
182	08/19	STEVE KNECUM	KNECUM/FORSTALL RACING	A/BF-1650/4	215.164	182	STEVE KNECUM	FORSTALL/KNECUM/DELUCA	09/20
9516	09/16	JESSE MICHAUD	FAIRWAY MOTORSPORTS	A/BG-2000/4	221.692	182	STEVE KNECUM	FORSTALL/SABATINELLI/KNECUM	07/21
7625	07/19	DON HASS	HASS-SERAFINI RACING	A/BF-2000/4	242.548	1110	DEAN SABATINELLI	GORDON RACING	07/10
9444	09/16	GREG NEAL	TLN MOTORSPORTS	A/F-2000/4	230.688	9647	MARK GORDON	SCOTT GUTHRIE RACING	07/11
259	07/19	MIKE YURKO	YURKO RACING	A/BG-2000/4	204.171	1315	MARK DOTSON	MARK THE MECHANIC RACING	07/16
7625	07/22	SCOTT HORNER	HASS-SERAFINI RACING	A/BF-3000/4	244.262	1110	JESSE MICHAUD	SCOTT GUTHRIE RACING	09/16
9444	09/16	GREG NEAL	TLN MOTORSPORTS	A/G-3000/4	223.375	9647	MARK GORDON	GORDON RACING	07/11
7625	05/16	DON HASS	HASS-SERAFINI RACING	A/BG-3000+/4	167.241	9444	GREG NEAL	TLN MOTORSPORTS	09/16
7625	05/16	DON HASS	HASS-SERAFINI RACING	A/BF-3000+/4	164.650	259	MIKE YURKO	YURKO RACING	07/19
7625	05/16	DON HASS	HASS-SERAFINI RACING	A/BG-3001+/4	161.875	1110	DEAN SABATINELLI	SCOTT GUTHRIE RACING	07/10
7625	05/16	DON HASS	HASS-SERAFINI RACING	A/BF-3001+/4	222.716	7625	SCOTT HORNER	HASS-SERAFINI RACING	07/21
9635	07/15	GREG NEAL	TLN MOTORSPORTS	APS/G-250/4	167.532	9444	GREG NEAL	TLN MOTORSPORTS	09/16
9635	09/15	GREG NEAL	TLN MOTORSPORTS	APS/F-250/4	168.380	9444	GREG NEAL	TLN MOTORSPORTS	09/16
9635	09/15	GREG NEAL	TLN MOTORSPORTS	APS/BG-250/4	234.716	9647	SCOTT HORNER	MARK GORDON	07/11
					195.437	9647	SCOTT HORNER	MARK GORDON	07/11
					110.621	9635	GREG NEAL	TLN MOTORSPORTS	07/15
					105.569	9635	GREG NEAL	TLN MOTORSPORTS	09/15
					106.186	9635	GREG NEAL	TLN MOTORSPORTS	09/15
ALTERED PARTIAL STREAMLINER									

VEH #	DATE	DRIVER	TEAM	1.0	CLASS	1.5	VEH #	DRIVER	TEAM	DATE
9635	07/15	GREG NEAL	TLN MOTORSPORTS	106.186	APS/BF-250/4	107.332	9635	GREG NEAL	TLN MOTORSPORTS	07/15
9635	07/15	GREG NEAL	TLN MOTORSPORTS	108.154	APS/G-350/4	108.298	9635	GREG NEAL	TLN MOTORSPORTS	07/15
9635	07/15	GREG NEAL	TLN MOTORSPORTS	106.294	APS/F-350/4	106.822	9635	GREG NEAL	TLN MOTORSPORTS	07/15
9635	07/15	GREG NEAL	TLN MOTORSPORTS	109.110	APS/BG-350/4	110.945	9635	GREG NEAL	TLN MOTORSPORTS	07/15
9635	07/15	GREG NEAL	TLN MOTORSPORTS	108.523	APS/BF-350/4	108.326	9635	GREG NEAL	TLN MOTORSPORTS	07/15
9635	07/15	GREG NEAL	TLN MOTORSPORTS	108.500	APS/G-400/4	108.544	9635	GREG NEAL	TLN MOTORSPORTS	07/15
9635	07/15	GREG NEAL	TLN MOTORSPORTS	112.373	APS/F-400/4	112.681	9635	GREG NEAL	TLN MOTORSPORTS	07/15
9635	07/15	GREG NEAL	TLN MOTORSPORTS	109.344	APS/BG-400/4	110.848	9635	GREG NEAL	TLN MOTORSPORTS	07/15
9635	07/15	GREG NEAL	TLN MOTORSPORTS	111.311	APS/BF-400/4	112.583	9635	GREG NEAL	TLN MOTORSPORTS	07/15
9635	07/15	GREG NEAL	TLN MOTORSPORTS	110.527	APS/G-500/4	110.586	9635	GREG NEAL	TLN MOTORSPORTS	07/15
9635	07/15	GREG NEAL	TLN MOTORSPORTS	110.447	APS/F-500/4	110.287	9635	GREG NEAL	TLN MOTORSPORTS	07/15
9635	07/15	GREG NEAL	TLN MOTORSPORTS	110.155	APS/BG-500/4	109.834	9635	GREG NEAL	TLN MOTORSPORTS	07/15
9635	09/15	GREG NEAL	TLN MOTORSPORTS	104.171	APS/BF-500/4	103.670	9635	GREG NEAL	TLN MOTORSPORTS	09/15
9444	07/16	GREG NEAL	TLN MOTORSPORTS	188.490	APS/G-650/4	194.235	9444	GREG NEAL	TLN MOTORSPORTS	07/16
119	05/16	GREG NEAL	TLN MOTORSPORTS	188.273	APS/F-650/4	190.987	119	GREG NEAL	TLN MOTORSPORTS	05/16
9444	07/16	GREG NEAL	TLN MOTORSPORTS	189.575	APS/BG-650/4	192.355	9444	GREG NEAL	TLN MOTORSPORTS	07/16
334	07/17	PATRICK LESSARD	G-FORCE	200.065	APS/BF-650/4	193.728	9444	GREG NEAL	TLN MOTORSPORTS	07/16
119	07/15	GREG NEAL	TLN MOTORSPORTS	188.346	APS/G-750/4	192.165	119	GREG NEAL	TLN MOTORSPORTS	07/15
9444	07/16	GREG NEAL	TLN MOTORSPORTS	187.306	APS/F-750/4	192.365	9444	GREG NEAL	TLN MOTORSPORTS	07/16
765	09/17	JOSEPH DALY	FAIRWAY MOTORSPORTS	197.612	APS/BG-750/4	200.155	765	JOSEPH DALY	FAIRWAY MOTORSPORTS	09/17
765	09/17	CLIFF DALY	FAIRWAY MOTORSPORTS	202.953	APS/BF-750/4	206.158	765	CLIFF DALY	FAIRWAY MOTORSPORTS	09/17
9731	07/12	GREG NEAL	TLN MOTORSPORTS	201.827	APS/G-1000/4	207.702	9731	GREG NEAL	TLN MOTORSPORTS	07/12
9444	09/16	GREG NEAL	TLN MOTORSPORTS	187.152	APS/F-1000/4	203.536	9731	GREG NEAL	TLN MOTORSPORTS	08/10
9731	09/12	GREG NEAL	TLN MOTORSPORTS	202.290	APS/BG-1000/4	204.940	9731	GREG NEAL	TLN MOTORSPORTS	09/12
9444	09/16	GREG NEAL	TLN MOTORSPORTS	186.011	APS/BF-1000/4	205.301	1440	DEAN SABATINELLI	TLN MOTORSPORTS	08/10
9290	07/16	GREG NEAL	TLN MOTORSPORTS	203.222	APS/G-1350/4	207.858	9731	GREG NEAL	TLN MOTORSPORTS	07/12
469	07/22	KRIS POULIN	#TEAM469	195.886	APS/BG-1350/4	264.130	1110	DEAN SABATINELLI	H&H RACING	07/16
5113	07/13	BILL WARNER	WARNER/FORSTALL RACING	296.128	APS/BF-1350/4	311.945	5113	BILL WARNER	WARNER/FORSTALL RACING	07/11
909	07/18	JOE ROBINSON	I NEED COFFEE	205.313	APS/G-1650/4	212.482	909	JOE ROBINSON	I NEED COFFEE	07/18
7607	07/13	JENNIFER ROBERTSON	OSTERGARD RACING	229.683	APS/F-1650/4	234.056	7607	JENNIFER ROBERTSON	OSTERGARD RACING	07/13
L200	09/15	HUSSAIN ALSOWAIGH	ALSOWAIGH RACING	238.365	APS/BG-1650/4	267.006	1110	DEAN SABATINELLI	SCOTT GUTHRIE RACING	08/10
5113	07/12	BILL WARNER	WARNER/FORSTALL RACING	290.294	APS/BF-1650/4	262.161	9494	THOMAS CRONAN	DAS PERFORMANCE	07/12
757	09/16	BRENDA SUE CARVER	CARNEFOR RACING	223.697	APS/G-2000/4	206.203	9731	GREG NEAL	TLN MOTORSPORTS	07/12
7628	07/22	THOMAS CRONAN	BLACK BART RACING	203.606	APS/F-2000/4	228.038	1302	JOSH OWEN	SCOTT GUTHRIE RACING	08/09
L1554	07/17	EDWARD MANES	RAVEN RACING	223.149	APS/BG-2000/4	266.130	1110	DEAN SABATINELLI	SCOTT GUTHRIE RACING	08/10
121H	07/16	SCOTT DAVIS	COLOR ME GONE RACING	263.190	APS/BF-3000/4	223.183	121H	SCOTT DAVIS	COLOR ME GONE RACING	07/17
L155	09/16	ED MANES	RAVEN RACING	202.825	APS/G-3000/4	207.729	L155	ALAN MANES	RAVEN RACING	09/16
9290	07/17	RANSOM HOLBROOK	H&H RACING	203.612	APS/F-3000/4	213.471	9290	RANSOM HOLBROOK	H&H RACING	07/17
L1001	07/16	RASHID AL-HAJRI	MK RACING	261.114	APS/BG-3000/4	266.919	1110	DEAN SABATINELLI	SCOTT GUTHRIE RACING	08/10
121H	07/16	SCOTT DAVIS	COLOR ME GONE RACING	249.568	APS/BF-3000/4	266.553	121H	SCOTT DAVIS	COLOR ME GONE RACING	07/16
9731	07/12	GREG NEAL	TLN MOTORSPORTS	198.798	APS/G-3001+4	204.509	9731	GREG NEAL	TLN MOTORSPORTS	07/12
7628	07/22	THOMAS CRONAN	BLACK BART RACING	203.317	APS/F-3001+4	205.039	1302	DONNA TIMNEY	SCOTT GUTHRIE RACING	08/09
7628	07/22	THOMAS CRONAN	BLACK BART RACING	184.891	APS/BG-3001+4	169.776	1110	DEAN SABATINELLI	SCOTT GUTHRIE RACING	08/10
265	07/19	SHANE STUBBS	TREDWAY STUBBS RACING	256.167	APS/BF-3001+4	264.739	265	SHANE STUBBS	TREDWAY STUBBS RACING	07/19

VEH #	DATE	DRIVER	TEAM	1.0	CLASS	1.5	VEH #	DRIVER	TEAM	DATE
265	07/19	SHANE STUBBS	TREDWAY STUBBS RACING	257.243	UPS/BF-1350/4	243.832	265	SHANE STUBBS	TREDWAY STUBBS RACING	07/19
SIDECAR										
148	09/18	PAUL KOEHLER	GEERHED RACING	107.363	SC/G-750/4	110.367	148	PAUL KOEHLER	GEERHED RACING	09/18
719	07/18	TOM CROMPTON	KRYPTON RACING	44.642	SC/G-1350/4	45.918	719	TOM CROMPTON	KRYPTON RACING	07/18
					SC/G-1350/4	166.982	1111	TODD DROSS	SCOTT GUTHRIE RACING	08/10
					SC/F-1350/4	176.470	1111	TODD DROSS	SCOTT GUTHRIE RACING	07/10
					SC/BF-1350/4	181.680	9669	EDDIE POWELL	POWELL RACING	09/11
					SC/F-1650/4	175.411	1111	TODD DROSS	SCOTT GUTHRIE RACING	07/10
9669	09/12	EDDIE POWELL	POWELL RACING	182.331	SC/BG-1650/4	189.784	9669	EDDIE POWELL	POWELL RACING	09/12
9669	07/13	EDDIE POWELL	POWELL RACING	201.188	SC/BF-1650/4	197.839	9669	EDDIE POWELL	POWELL RACING	07/13
					SC/F-2000/4	171.520	1111	TODD DROSS	SCOTT GUTHRIE RACING	07/10
					SC/F-3000/4	175.891	1111	TODD DROSS	SCOTT GUTHRIE RACING	07/10
STREAMLINER										
OPEN										
SIDECAR STREAMLINER										
OPEN										
PUSHROD CATEGORY										
PURE PRODUCTION										
8949	08/19	TOM REAY	OLD FART RACING	141.492	PP/PP-1000/4	144.206	8949	TOM REAY	OLD FART RACING	08/19
515	07/21	TOM SCHAEFER	MYLAWVERTOM.COM	163.469	PP/PP-1650/4	162.929	515	TOM SCHAEFER	MYLAWVERTOM.COM	07/21
PRODUCTION										
9056	07/12	CLIFF DALY	FAIRWAY MOTORSPORTS	41.860	P/PP-100/4	39.592	9056	CLIFF DALY	FAIRWAY MOTORSPORTS	07/12
9056	07/14	CLIFF DALY	FAIRWAY MOTORSPORTS	33.272	P/PP-125/4	32.986	9056	CLIFF DALY	FAIRWAY MOTORSPORTS	07/14
1142	07/12	PIERRE LAFRANCE	PIERRE LAFRANCE	108.332	P/PP-500/4	110.351	1142	PIERRE LAFRANCE	PIERRE LAFRANCE	07/12
6116	09/16	JERRY DINNEN	DINNEN RACING	130.438	P/BPP-500/4	133.065	6116	JERRY DINNEN	DINNEN RACING	09/16
					P/PP-650/4	124.663	9421	MICHAEL GONI	PRT RACING	07/12
9121	07/12	THOMAS CRONAN	BLACK BART RACING	131.961	P/PP-750/4	133.052	9121	THOMAS CRONAN	BLACK BART RACING	07/12
8949	09/17	TOM REAY	OLD FART RACING	141.693	P/PP-1000/4	146.631	8949	TOM REAY	OLD FART RACING	09/17
8949	07/21	TOM REAY	OLD FART RACING	150.241	P/PP-1350/4	153.076	8949	TOM REAY	OLD FART RACING	07/21
1650	09/18	ROBERT SWARTZ	MOTUS OF N/E	165.700	P/PP-1650/4	169.636	1650	ROBERT SWARTZ	MOTUS OF N/E	09/18
515	07/21	TOM SCHAEFER	MYLAWVERTOM.COM	162.400	P/PP-2000/4	162.788	515	TOM SCHAEFER	MYLAWVERTOM.COM	07/21
515	07/21	TOM SCHAEFER	MYLAWVERTOM.COM	162.801	P/PP-3000/4	162.965	515	TOM SCHAEFER	MYLAWVERTOM.COM	07/21
MODIFIED										
9056	07/14	CLIFF DALY	FAIRWAY MOTORSPORTS	40.277	M/PG-100/4	40.758	9056	CLIFF DALY	FAIRWAY MOTORSPORTS	07/14
9856	07/18	TOM BORCHERTD	LOOK OUT! RACING	99.861	M/PG-250/4	100.671	9856	TOM BORCHERTD	LOOK OUT! RACING	07/18
9906	08/13	TOM CROMPTON	KRYPTON RACING	60.446	M/PVG-250/4	61.546	9906	TOM CROMPTON	KRYPTON RACING	08/13
					M/PG-350/4	75.545	1400	LLOYD W. FRINK IV	STERLING HILL GANG	07/11
					M/PF-350/4	84.136	1400	LLOYD W. FRINK IV	STERLING HILL GANG	08/09
					M/PF-400/4	85.233	1400	LLOYD W. FRINK IV	STERLING HILL GANG	08/09

VEH #	DATE	DRIVER	TEAM	1.0	CLASS	1.5	VEH #	DRIVER	TEAM	DATE
9980	07/18	JENNIFER BOOKHAMER	BOOKHAMER RACING	124.169	M/PG-500/4	122.980	9980	JENNIFER BOOKHAMER	BOOKHAMER RACING	07/18
950	07/21	NORMAN MILLS	MILLS RACING	65.795	M/PBG-500/4	76.882	1400	LOYD W. FRINK IV	STERLING HILL GANG	07/11
71	07/17	TOM CROMPTON	KRYPTON RACING	96.446	M/PPVG-500/4	97.257	71	TOM CROMPTON	KRYPTON RACING	07/17
9115	09/18	KEVIN ROBERTS	TEAM PREHISTORIC	133.003	M/PG-650/4	135.260	9115	KEVIN ROBERTS	TEAM PREHISTORIC	09/18
9260	07/17	LYIHA WILTON	ROUGH EDGES RACING	127.794	M/PE-650/4	130.315	9260	LYIHA WILTON	ROUGH EDGES RACING	07/17
					M/PBG-650/4	88.149	1402	LOYD FRINK SR	STERLING HILL GANG	09/11
					M/PBG-650/4	85.894	1402	LOYD FRINK SR	STERLING HILL GANG	09/11
9121	08/13	THOMAS CRONAN	BLACK BART RACING	135.943	M/PG-750/4	137.514	9121	THOMAS CRONAN	BLACK BART RACING	08/13
					M/PE-750/4	134.394	9512	MIKE TOMANY	TOMANY RACING	09/11
9845	09/17	ANDY COX	KINGSTREET CYCLES	146.732	M/PG-1000/4	156.244	417	MARK RUBIN	MARK RUBIN	08/09
2311	07/21	MIKE TIBERIO	TIBER RIVER RACING	136.050	M/PE-1000/4	137.373	2311	MIKE TIBERIO	TIBER RIVER RACING	07/21
9216	07/13	CLIFF DALY	FAIRWAY MOTORSPORTS	133.885	M/PG-1350/4	135.668	9216	CLIFF DALY	FAIRWAY MOTORSPORTS	07/13
1908	04/15	JESSE MICHAUD	ROCKET SURGERY RACING	103.271	M/PE-1350/4	122.563	1403	TRAVIS FRINK	STERLING HILL GANG	07/17
231	07/17	SCOTT SETTINO	FTF CYCLES	141.893	M/PG-1650/4	142.268	231	SCOTT SETTINO	FTF CYCLES	07/17
231	07/17	SCOTT SETTINO	FTF CYCLES	144.236	M/PE-1650/4	141.669	231	SCOTT SETTINO	FTF CYCLES	07/17
231	08/18	DAN PIKE	FTF CYCLES	132.355	M/PBG-1650/4	135.709	231	DAN PIKE	FTF CYCLES	08/18
231	08/18	DAN PIKE	FTF CYCLES	135.395	M/PBF-1650/4	137.823	231	DAN PIKE	FTF CYCLES	08/18
231	09/18	DAN PIKE	FTF CYCLES	148.956	M/PG-2000/4	151.761	231	DAN PIKE	FTF CYCLES	09/18
231	09/17	DAN PIKE	FTF CYCLES	141.288	M/PE-2000/4	140.879	231	DAN PIKE	FTF CYCLES	09/17
9769	08/13	CARL THERIAULT	ZOOMZOOMZOOM RACING	129.519	M/PBG-2000/4	129.491	9501	JON DILLINGHAM	JON DILLINGHAM	08/13
9769	08/13	CARL THERIAULT	ZOOMZOOMZOOM RACING	129.482	M/PE-3000/4	129.320	9769	CARL THERIAULT	ZOOMZOOMZOOM RACING	08/13
9769	08/13	CARL THERIAULT	ZOOMZOOMZOOM RACING	128.953	M/PBF-3000/4	129.266	9769	CARL THERIAULT	ZOOMZOOMZOOM RACING	08/13

MODIFIED PARTIAL STREAMLINER

937	07/17	JOHN BENNETT	FIVEANDDIME RACING	89.647	MPS/PG-100/4	78.717	1137	BILL PAULOVICIN	TEAM DOUGHERTY	07/11
9632	09/12	TOM CROMPTON	KRYPTON RACING	72.666	MPS/PE-350/4	88.427	937	JOHN BENNETT	FIVEANDDIME RACING	07/17
9980	07/18	JENNIFER BOOKHAMER	BOOKHAMER RACING	124.246	MPS/PG-500/4	171.680	9632	TOM CROMPTON	KRYPTON RACING	09/12
9543	05/16	MIKE GONI	PRT RACING	135.400	MPS/PG-650/4	138.691	9980	JENNIFER BOOKHAMER	BOOKHAMER RACING	07/18
9543	07/14	MICHAEL GONI	PRT RACING	149.141	MPS/PE-650/4	155.654	1140	MATT DICK	MD RACING	05/16
9543	07/17	MIKE GONI	PRT RACING	138.310	MPS/PBG-650/4	142.943	9543	MIKE GONI	PRT RACING	07/17
9543	07/18	MIKE GONI	PRT RACING	161.318	MPS/PBF-650/4	166.030	9543	MIKE GONI	PRT RACING	07/18
9270	07/22	CHRISTOPHER NEWTON	BLOWN INCOME	130.302	MPS/PG-750/4	132.536	9270	CHRISTOPHER NEWTON	BLOWN INCOME	07/22
9512	09/12	MIKE TOMANY	TOMANY RACING	142.159	MPS/PE-750/4	146.521	9512	MIKE TOMANY	TOMANY RACING	09/12
8849	07/19	TOM REAY	OLD FART RACING	145.066	MPS/PBF-750/4	158.666	9543	CARL T. SCHAEFER	PRT RACING	07/19
9512	05/16	MIKE TOMANY	TOMANY RACING	146.661	MPS/PG-1000/4	147.727	8849	TOM REAY	OLD FART RACING	07/19
8849	07/22	TOM REAY	OLD FART RACING	149.064	MPS/PE-1000/4	151.403	9512	MIKE TOMANY	TOMANY RACING	07/16
8849	07/21	TOM REAY	OLD FART RACING	149.487	MPS/PG-1350/4	154.088	8849	TOM REAY	OLD FART RACING	07/21
9216	07/13	JOSEPH DALY	FAIRWAY MOTORSPORTS	133.899	MPS/PBF-1350/4	152.329	8949	TOM REAY	OLD FART RACING	07/22
515	07/21	TOM SCHAEFER	MFLAWYERTOM.COM	163.239	MPS/PG-1650/4	161.742	515	JOSEPH DALY	FAIRWAY MOTORSPORTS	07/13
515	07/21	TOM SCHAEFER	MFLAWYERTOM.COM	163.545	MPS/PE-1650/4	163.070	515	TOM SCHAEFER	MFLAWYERTOM.COM	07/21
515	07/21	TOM SCHAEFER	MFLAWYERTOM.COM	160.814	MPS/PBF-1650/4	162.784	515	TOM SCHAEFER	MFLAWYERTOM.COM	07/21
515	07/21	TOM SCHAEFER	MFLAWYERTOM.COM	161.242	MPS/PBF-1650/4	161.750	515	TOM SCHAEFER	MFLAWYERTOM.COM	07/21

VEH #	DATE	DRIVER	TEAM	1.0	CLASS	1.5	VEH #	DRIVER	TEAM	DATE	
515	07/21	TOM SCHAEFER	M/LAWYERTOM.COM	45.957	MPS/PG-2000/4	10.005	515	TOM SCHAEFER	M/LAWYERTOM.COM	07/21	
515	07/21	TOM SCHAEFER	M/LAWYERTOM.COM	160.244	MPS/PF-2000/4	158.307	515	TOM SCHAEFER	M/LAWYERTOM.COM	07/21	
L152	08/14	JON DOICK	US TRANSPORTER RACING	148.270	MPS/PBG-2000/4	160.296	515	TOM SCHAEFER	M/LAWYERTOM.COM	07/21	
515	07/21	TOM SCHAEFER	M/LAWYERTOM.COM	157.978	MPS/PBF-2000/4	159.209	515	TOM SCHAEFER	M/LAWYERTOM.COM	07/21	
515	07/21	TOM SCHAEFER	M/LAWYERTOM.COM	162.061	MPS/PG-3000/4	161.683	515	TOM SCHAEFER	M/LAWYERTOM.COM	07/21	
515	07/21	TOM SCHAEFER	M/LAWYERTOM.COM	162.426	MPS/PF-3000/4	161.884	515	TOM SCHAEFER	M/LAWYERTOM.COM	07/21	
515	07/21	TOM SCHAEFER	M/LAWYERTOM.COM	57.268	MPS/PBG-3000/4	60.287	515	TOM SCHAEFER	M/LAWYERTOM.COM	07/21	
515	07/21	TOM SCHAEFER	M/LAWYERTOM.COM	148.617	MPS/PBF-3000/4	156.703	515	TOM SCHAEFER	M/LAWYERTOM.COM	07/21	
ALTERED											
9616	07/17	STACY ROBEY	FAIRWAY MOTORSPORTS	65.289	A/PG-250/4	59.676	9616	STACY ROBEY	FAIRWAY MOTORSPORTS	07/17	
9616	09/17	STACY ROBEY	FAIRWAY MOTORSPORTS	77.346	A/PF-250/4	79.067	9616	STACY ROBEY	FAIRWAY MOTORSPORTS	09/17	
9616	09/18	STACY ROBEY	FAIRWAY MOTORSPORTS	68.863	A/PBF-250/4	68.410	9616	STACY ROBEY	FAIRWAY MOTORSPORTS	09/18	
					A/PG-350/4	72.490	1400	LLOYD W. FRINK IV	STERLING HILL GANG	07/10	
					A/PF-350/4	73.671	1400	LLOYD W. FRINK IV	STERLING HILL GANG	07/10	
					A/PBG-350/4	76.964	1400	LLOYD W. FRINK IV	STERLING HILL GANG	08/10	
					A/PBF-350/4	77.844	1400	LLOYD W. FRINK IV	STERLING HILL GANG	08/10	
9433	07/13	JOHN PETSCH	PETSCH RACING	60.269	A/PBAF-350/4	56.535	9433	JOHN PETSCH	PETSCH RACING	07/13	
					A/PG-400/4	76.052	1400	LLOYD W. FRINK IV	STERLING HILL GANG	07/10	
					A/PF-400/4	77.086	1400	LLOYD W. FRINK IV	STERLING HILL GANG	08/10	
					A/PBG-400/4	76.982	1400	LLOYD W. FRINK IV	STERLING HILL GANG	08/10	
					A/PBF-400/4	75.204	1400	LLOYD W. FRINK IV	STERLING HILL GANG	08/10	
					A/PAF-350/4	56.535	9433	JOHN PETSCH	PETSCH RACING	07/11	
9216	07/18	JESSE MICHAUD	FAIRWAY MOTORSPORTS	108.477	A/PG-500/4	117.918	9452	TOM BORCHERT	LOOK OUT! RACING	07/11	
1197	05/16	DAN DAUGHENBAUGH	GREASY GRINGO RACING	98.096	A/PF-500/4	85.685	1197	DAN DAUGHENBAUGH	GREASY GRINGO RACING	04/15	
1197	04/15	DAN DAUGHENBAUGH	GREASY GRINGO RACING	87.369	A/PVF-500/4	82.361	1197	DAN DAUGHENBAUGH	GREASY GRINGO RACING	04/15	
780	08/19	KYLE MALINKY	LOW BROW RACING	131.942	A/PG-650/4	136.248	780	KYLE MALINKY	LOW BROW RACING	08/19	
					A/PBF-650/4	77.384	1402	LLOYD FRINK SR	STERLING HILL GANG	09/11	
889	05/16	RAY ROBERTS	TEAM ROBERTS	131.486	A/PBF-650/4	85.904	1402	LLOYD FRINK SR	STERLING HILL GANG	09/11	
1197	04/15	DAN DAUGHENBAUGH	GREASY GRINGO RACING	86.469	A/PVF-650/4	79.709	1197	DAN DAUGHENBAUGH	GREASY GRINGO RACING	04/15	
9313	07/19	THOMAS CRONIN	BLACK BART RACING	146.482	A/PG-750/4	148.850	9313	THOMAS CRONIN	BLACK BART RACING	07/19	
9313	07/19	THOMAS CRONIN	BLACK BART RACING	144.542	A/PF-750/4	146.861	9313	THOMAS CRONIN	BLACK BART RACING	07/19	
9313	07/19	THOMAS CRONIN	BLACK BART RACING	144.131	A/PBG-750/4	144.624	9313	THOMAS CRONIN	BLACK BART RACING	07/19	
9313	07/19	THOMAS CRONIN	BLACK BART RACING	145.821	A/PBF-750/4	145.821	9313	THOMAS CRONIN	BLACK BART RACING	07/19	
9216	07/22	JAMIE DALY	FAIRWAY MOTORSPORTS	140.755	A/PG-1000/4	143.689	9216	JAMIE DALY	FAIRWAY MOTORSPORTS	07/22	
9216	05/16	JESSE MICHAUD	SUNNYVALE RACING	133.706	A/PF-1000/4	138.066	9216	JESSE MICHAUD	SUNNYVALE RACING	05/16	
9313	07/22	THOMAS CRONAN	BLACK BART RACING	138.709	A/PBG-1000/4	141.415	9313	THOMAS CRONAN	BLACK BART RACING	07/22	
9313	07/22	THOMAS CRONAN	BLACK BART RACING	133.982	A/PBF-1000/4	134.464	9313	THOMAS CRONAN	BLACK BART RACING	07/22	
9701	07/18	PANHEAD PAT	HOOHA RACING	161.094	A/PF-1350/4	162.861	9701	PANHEAD PAT	HOOHA RACING	07/18	
					A/PF-1350/4	153.848	9116	JOE DALY	FAIRWAY MOTORSPORTS	07/10	
9313	07/22	THOMAS CRONAN	BLACK BART RACING	132.173	A/PBG-1350/4	132.408	9313	THOMAS CRONAN	BLACK BART RACING	07/22	
9313	07/22	THOMAS CRONAN	BLACK BART RACING	131.354	A/PBF-1350/4	133.741	9313	THOMAS CRONAN	BLACK BART RACING	07/22	
7403	07/15	JIM FISHER	GRAY GHOST PROJECT	177.296	A/PG-1650/4	179.993	7403	JIM FISHER	GRAY GHOST PROJECT	07/15	
7403	07/15	JIM FISHER	GRAY GHOST PROJECT	177.189	A/PF-1650/4	180.232	7403	JIM FISHER	GRAY GHOST PROJECT	07/15	

VEH #	DATE	DRIVER	TEAM	1.0	CLASS	1.5	VEH #	DRIVER	TEAM	DATE
74	07/18	MICHAEL WITT	GRAY GHOST II PROJECT	170.708	A/PBG-1650/4	164.487	264	JODY PEREWITZ	TEAM JWITZ	07/11
9313	07/22	THOMAS CRONAN	BLACK BART RACING	110.204	A/PBF-1650/4					
259	07/19	MIKE YURKO	YURKO RACING	182.574	A/PBG-2000/4	187.550	259	MIKE YURKO	YURKO RACING	07/19
259	07/19	MIKE YURKO	YURKO RACING	177.744	A/PF-2000/4	181.326	259	MIKE YURKO	YURKO RACING	07/19
264	09/15	JODY PEREWITZ	TEAM JWITZ	185.110	A/PBG-2000/4	192.780	264	JODY PEREWITZ	TEAM JWITZ	09/15
259	07/22	MIKE YURKO	YURKO RACING	173.707	A/PBF-2000/4	179.813	259	MIKE YURKO	YURKO RACING	07/22
L259	07/16	MIKE YURKO	YURKO RACING	173.161	A/PBG-3000/4	177.407	L259	MIKE YURKO	YURKO RACING	07/16
259	07/19	MIKE YURKO	YURKO RACING	180.253	A/PF-3000/4	186.806	259	MIKE YURKO	YURKO RACING	07/19
259	07/18	MIKE YURKO	YURKO RACING	168.018	A/PBG-3000/4	170.811	259	MIKE YURKO	YURKO RACING	07/18
259	07/18	MIKE YURKO	YURKO RACING	165.844	A/PBF-3000/4	169.202	259	MIKE YURKO	YURKO RACING	07/18
ALTERED PARTIAL STREAMLINER										
9459	07/13	TOM BORCHERT	LOOK OUT! RACING	132.973	APS/PF-500/4	140.516	9459	TOM BORCHERT	LOOK OUT! RACING	07/13
1197	09/15	DAN DAUGHENBAUGH	GREASY GRINGO RACING	96.304	APS/PVF-500/4	80.040	1197	DAN DAUGHENBAUGH	GREASY GRINGO RACING	09/15
9459	07/15	TOM BORCHERT	LOOK OUT! RACING	145.238	APS/PF-650/4	152.866	9459	TOM BORCHERT	LOOK OUT! RACING	07/15
9313	07/18	THOMAS CRONAN	BLACK BART RACING	149.719	APS/PF-750/4	152.872	9313	THOMAS CRONAN	BLACK BART RACING	07/18
9313	07/17	THOMAS CRONAN	BLACK BART RACING	147.403	APS/PF-750/4	149.148	9313	THOMAS CRONAN	BLACK BART RACING	07/17
9313	07/17	THOMAS CRONAN	BLACK BART RACING	146.176	APS/PBG-750/4	147.630	9313	THOMAS CRONAN	BLACK BART RACING	07/17
9313	07/17	THOMAS CRONAN	BLACK BART RACING	147.249	APS/PBF-750/4	149.278	9313	THOMAS CRONAN	BLACK BART RACING	07/17
9576	09/12	JOE DALY	FAIRWAY MOTORSPORTS	134.937	APS/PF-1000/4	134.836	9576	JOE DALY	FAIRWAY MOTORSPORTS	09/12
9282	09/17	JOHN PETSCH	PETSCH RACING	85.046	APS/PF-1000/4	86.529	9282	JOHN PETSCH	PETSCH RACING	09/17
7403	07/16	JIM FISCHER	GRAY GHOST PROJECT	186.741	APS/PF-1650/4	194.644	7403	JIM FISCHER	GRAY GHOST PROJECT	07/16
7403	07/15	JIM FISCHER	GRAY GHOST PROJECT	185.885	APS/PF-1650/4	193.202	7403	JIM FISCHER	GRAY GHOST PROJECT	07/15
264	07/12	JODY PEREWITZ	TEAM JWITZ	191.115	APS/PBG-1650/4	186.119	264	JODY PEREWITZ	TEAM JWITZ	07/12
264	07/13	JODY PEREWITZ	TEAM JWITZ	193.414	APS/PBF-1650/4	202.945	264	JODY PEREWITZ	TEAM JWITZ	07/13
74	07/17	JIM FISCHER	GRAY GHOST PROJECT	187.121	APS/PF-2000/4	191.322	74	JIM FISCHER	GRAY GHOST PROJECT	07/17
74	07/17	JIM FISCHER	GRAY GHOST PROJECT	182.134	APS/PF-2000/4	189.493	74	JIM FISCHER	GRAY GHOST PROJECT	07/17
259	07/19	MIKE YURKO	YURKO RACING	180.160	APS/PBG-2000/4	184.936	259	MIKE YURKO	YURKO RACING	07/19
264	07/17	JODY PEREWITZ	TEAM JWITZ	192.852	APS/PBF-2000/4	199.600	264	JODY PEREWITZ	TEAM JWITZ	07/17
259	07/18	MIKE YURKO	YURKO RACING	174.118	APS/PF-3000/4	177.146	259	MIKE YURKO	YURKO RACING	07/18
259	07/18	MIKE YURKO	YURKO RACING	178.044	APS/PF-3000/4	181.738	259	MIKE YURKO	YURKO RACING	07/18
259	07/22	MIKE YURKO	YURKO RACING	166.675	APS/PBG-3000/4	172.792	259	MIKE YURKO	YURKO RACING	07/22
259	07/22	MIKE YURKO	YURKO RACING	167.325	APS/PBF-3000/4	169.948	259	MIKE YURKO	YURKO RACING	07/22
SIDECAR										
L250	05/16	JESSE MICHAUD	SUNNYVALE RACING	48.666	SC/PF-250/4	52.278	L250	JESSE MICHAUD	SUNNYVALE RACING	05/16
1402	07/18	LLOYD FRINK SR	STERLING HILL GANG	110.120	SC/PF-1350/4	110.592	1402	LLOYD FRINK SR	STERLING HILL GANG	07/18
1402	07/18	LLOYD FRINK SR	STERLING HILL GANG	107.365	SC/PF-1350/4	109.483	1402	LLOYD FRINK SR	STERLING HILL GANG	07/18
1402	07/18	LLOYD FRINK SR	STERLING HILL GANG	106.318	SC/PBG-1350/4	105.902	1402	LLOYD FRINK SR	STERLING HILL GANG	07/18
1402	07/18	LLOYD FRINK SR	STERLING HILL GANG	124.032	SC/PBF-1350/4	131.363	1402	LLOYD FRINK SR	STERLING HILL GANG	07/18
1402	07/16	LLOYD FRINK SR	STERLING HILL GANG	115.912	SC/PF-1650/4	119.833	1402	LLOYD FRINK SR	STERLING HILL GANG	07/16
STREAMLINER										
OPEN										
SIDECAR STREAMLINER										
OPEN										

68

VEH #	DATE	DRIVER	TEAM	CLASS	1.0	1.5	VEH #	DRIVER	TEAM	DATE	
2-STROKE CATEGORY											
PURE PRODUCTION											
924	08/21	TOM SCHAEFER	MYLAWYERTOM.COM	PP/P-175/2	85.080	85.710	924	TOM SCHAEFER	MYLAWYERTOM.COM	08/21	
721	09/21	RICHARD PROSSER JR	RPM LAND SPEED	PP/P-250/2	96.504	98.427	721	RICHARD PROSSER JR	RPM LAND SPEED	09/21	
L147	09/18	JASON ROBEY	ROBEY RACING	PP/P-350/2	116.011	115.377	769	TOM SCHAEFER	MYLAWYERTOM.COM	07/21	
OPEN											
PRODUCTION											
9548	05/16	FRANK JOHN	FJ RACING	P/P-125/2	76.132	77.013	9548	FRANK JOHN	FJ RACING	05/16	
924	08/21	TOM SCHAEFER	MYLAWYERTOM.COM	P/P-175/2	84.826	84.060	924	TOM SCHAEFER	MYLAWYERTOM.COM	08/21	
924	08/21	TOM SCHAEFER	MYLAWYERTOM.COM	P/BP-175/2	84.225	84.081	924	TOM SCHAEFER	MYLAWYERTOM.COM	08/21	
721	09/21	RICHARD PROSSER JR	RPM LAND SPEED	P/P-250/2	96.633	95.905	721	RICHARD PROSSER JR	RPM LAND SPEED	09/21	
721	09/21	RICHARD PROSSER JR	RPM LAND SPEED	P/BP-250/2	97.723	97.957	721	RICHARD PROSSER JR	RPM LAND SPEED	09/21	
769	07/21	TOM SCHAEFER	MYLAWYERTOM.COM	P/P-350/2	113.618	113.968	769	TOM SCHAEFER	MYLAWYERTOM.COM	07/21	
769	07/21	TOM SCHAEFER	MYLAWYERTOM.COM	P/BP-350/2	111.790	109.931	769	TOM SCHAEFER	MYLAWYERTOM.COM	07/21	
769	07/21	TOM SCHAEFER	MYLAWYERTOM.COM	P/P-400/2	112.683	113.758	769	TOM SCHAEFER	MYLAWYERTOM.COM	07/21	
769	07/21	TOM SCHAEFER	MYLAWYERTOM.COM	P/BP-400/2	114.348	114.409	769	TOM SCHAEFER	MYLAWYERTOM.COM	07/21	
9548	07/12	FRANK JOHN	FJ RACING	P/P-500/2	116.698	117.141	9548	FRANK JOHN	FJ RACING	07/12	
769	07/21	TOM SCHAEFER	MYLAWYERTOM.COM	P/BP-500/2	110.387	110.121	769	TOM SCHAEFER	MYLAWYERTOM.COM	07/21	
9548	07/14	FRANK JOHN	FJ RACING	P/P-650/2	111.825	112.409	9548	FRANK JOHN	FJ RACING	07/14	
769	07/21	TOM SCHAEFER	MYLAWYERTOM.COM	P/BP-650/2	115.432	115.483	769	TOM SCHAEFER	MYLAWYERTOM.COM	07/21	
769	07/21	TOM SCHAEFER	MYLAWYERTOM.COM	P/P-750/2	115.172	115.329	769	TOM SCHAEFER	MYLAWYERTOM.COM	07/21	
769	07/21	TOM SCHAEFER	MYLAWYERTOM.COM	P/BP-750/2	116.079	118.017	769	TOM SCHAEFER	MYLAWYERTOM.COM	07/21	
769	07/21	TOM SCHAEFER	MYLAWYERTOM.COM	P/P-1000/2	114.672	116.508	769	TOM SCHAEFER	MYLAWYERTOM.COM	07/21	
769	07/21	TOM SCHAEFER	MYLAWYERTOM.COM	P/BP-1000/2	116.639	118.125	769	TOM SCHAEFER	MYLAWYERTOM.COM	07/21	
MODIFIED											
72	07/17	PRENT MARRINER	LARGE TIME RACING	M/G-100/2	66.191	64.514	72	PRENT MARRINER	LARGE TIME RACING	07/17	
924	09/21	TOM SCHAEFER	MYLAWYERTOM.COM	M/G-175/2	85.672	85.986	924	TOM SCHAEFER	MYLAWYERTOM.COM	09/21	
924	09/21	TOM SCHAEFER	MYLAWYERTOM.COM	M/G-175/2	84.491	86.155	924	TOM SCHAEFER	MYLAWYERTOM.COM	09/21	
924	09/21	TOM SCHAEFER	MYLAWYERTOM.COM	M/BG-175/2	85.582	84.031	924	TOM SCHAEFER	MYLAWYERTOM.COM	09/21	
924	09/21	TOM SCHAEFER	MYLAWYERTOM.COM	M/BF-175/2	83.215	83.558	924	TOM SCHAEFER	MYLAWYERTOM.COM	09/21	
L442	05/16	JIMI HEYDER	HEYDERACING	M/G-250/2	112.542	112.834	L442	JIMI HEYDER	HEYDERACING	05/16	
721	09/21	RICHARD PROSSER JR	RPM LAND SPEED	M/BG-250/2	96.658	96.356	721	RICHARD PROSSER JR	RPM LAND SPEED	09/21	
721	09/21	RICHARD PROSSER JR	RPM LAND SPEED	M/BF-250/2	97.947	97.964	721	RICHARD PROSSER JR	RPM LAND SPEED	09/21	
L144	07/16	TOM BORCHERT	LOOK OUT! RACING	M/BF-350/2	96.229	96.272	L1001	HUSSAIN ALSOWAIGH	ALSOWAIGH RACING	07/16	
769	08/21	TOM SCHAEFER	MYLAWYERTOM.COM	M/G-350/2	110.924	113.083	L144	TOM BORCHERT	LOOK OUT! RACING	07/16	
769	08/21	TOM SCHAEFER	MYLAWYERTOM.COM	P/P-350/2	104.698	104.489	769	TOM SCHAEFER	MYLAWYERTOM.COM	08/21	
769	08/21	TOM SCHAEFER	MYLAWYERTOM.COM	M/BG-350/2	101.781	104.984	769	TOM SCHAEFER	MYLAWYERTOM.COM	08/21	
769	08/21	TOM SCHAEFER	MYLAWYERTOM.COM	M/BF-350/2	97.832	101.386	769	TOM SCHAEFER	MYLAWYERTOM.COM	08/21	
769	07/21	TOM SCHAEFER	MYLAWYERTOM.COM	M/G-400/2	107.537	106.434	769	TOM SCHAEFER	MYLAWYERTOM.COM	07/21	
769	08/21	TOM SCHAEFER	MYLAWYERTOM.COM	M/BF-400/2	106.535	103.775	769	TOM SCHAEFER	MYLAWYERTOM.COM	08/21	
769	08/21	TOM SCHAEFER	MYLAWYERTOM.COM	M/BG-400/2	101.990	105.262	769	TOM SCHAEFER	MYLAWYERTOM.COM	08/21	
769	08/21	TOM SCHAEFER	MYLAWYERTOM.COM	M/BF-400/2	102.725	104.651	769	TOM SCHAEFER	MYLAWYERTOM.COM	08/21	
9943	09/15	FRANK JOHN	FJ RACING	M/G-500/2	105.425	104.971	9943	FRANK JOHN	FJ RACING	09/15	

VEH #	DATE	DRIVER	TEAM	1.0	CLASS	1.5	VEH #	DRIVER	TEAM	DATE
9943	09/15	FRANK JOHN	FJ RACING	103.540	M/F-500/2	104.687	9943	FRANK JOHN	FJ RACING	09/15
769	08/21	TOM SCHAEFER	MYLAWYERTOM.COM	100.578	M/BG-500/2	104.570	769	TOM SCHAEFER	MYLAWYERTOM.COM	08/21
769	07/21	TOM SCHAEFER	MYLAWYERTOM.COM	109.141	M/BF-500/2	108.688	769	TOM SCHAEFER	MYLAWYERTOM.COM	07/21
769	07/21	TOM SCHAEFER	MYLAWYERTOM.COM	109.443	M/G-650/2	108.935	769	TOM SCHAEFER	MYLAWYERTOM.COM	07/21
769	07/21	TOM SCHAEFER	MYLAWYERTOM.COM	109.443	M/F-650/2	108.935	769	TOM SCHAEFER	MYLAWYERTOM.COM	07/21
769	07/21	TOM SCHAEFER	MYLAWYERTOM.COM	107.667	M/BG-650/2	108.279	769	TOM SCHAEFER	MYLAWYERTOM.COM	07/21
769	07/21	TOM SCHAEFER	MYLAWYERTOM.COM	108.416	M/BF-650/2	107.704	769	TOM SCHAEFER	MYLAWYERTOM.COM	07/21
868	08/18	EDWARD FOX	TEAM LOW IQ	116.601	M/G-750/2	116.484	868	EDWARD FOX	TEAM LOW IQ	08/18
L188	09/16	EDDIE OBLINGER	BITTER MOTORSPORTS LSR	108.289	M/F-750/2	109.197	769	TOM SCHAEFER	MYLAWYERTOM.COM	07/21
769	07/21	TOM SCHAEFER	MYLAWYERTOM.COM	107.319	M/BG-750/2	107.284	769	TOM SCHAEFER	MYLAWYERTOM.COM	07/21
769	07/21	TOM SCHAEFER	MYLAWYERTOM.COM	107.910	M/BF-750/2	107.163	769	TOM SCHAEFER	MYLAWYERTOM.COM	07/21
769	07/21	TOM SCHAEFER	MYLAWYERTOM.COM	104.995	M/G-1000/2	106.309	769	TOM SCHAEFER	MYLAWYERTOM.COM	07/21
769	07/21	TOM SCHAEFER	MYLAWYERTOM.COM	106.931	M/F-1000/2	106.571	769	TOM SCHAEFER	MYLAWYERTOM.COM	07/21
769	07/21	TOM SCHAEFER	MYLAWYERTOM.COM	105.971	M/BG-1000/2	106.762	769	TOM SCHAEFER	MYLAWYERTOM.COM	07/21
769	07/21	TOM SCHAEFER	MYLAWYERTOM.COM	102.675	M/BF-1000/2					
769	09/21	TOM SCHAEFER	MYLAWYERTOM.COM	93.727	M/G-1350/2	94.745	769	TOM SCHAEFER	MYLAWYERTOM.COM	09/21
769	09/21	TOM SCHAEFER	MYLAWYERTOM.COM	92.515	M/F-1350/2	92.036	769	TOM SCHAEFER	MYLAWYERTOM.COM	09/21
769	09/21	TOM SCHAEFER	MYLAWYERTOM.COM	93.848	M/BG-1350/2	94.424	769	TOM SCHAEFER	MYLAWYERTOM.COM	09/21
769	09/21	TOM SCHAEFER	MYLAWYERTOM.COM	95.866	M/BF-1350/2	97.145	769	TOM SCHAEFER	MYLAWYERTOM.COM	09/21
769	09/21	TOM SCHAEFER	MYLAWYERTOM.COM	93.087	M/G-1650/2	93.891	769	TOM SCHAEFER	MYLAWYERTOM.COM	09/21
769	09/21	TOM SCHAEFER	MYLAWYERTOM.COM	89.836	M/F-1650/2	89.598	769	TOM SCHAEFER	MYLAWYERTOM.COM	09/21
769	09/21	TOM SCHAEFER	MYLAWYERTOM.COM	92.746	M/BG-1650/2	94.971	769	TOM SCHAEFER	MYLAWYERTOM.COM	09/21
769	09/21	TOM SCHAEFER	MYLAWYERTOM.COM	97.031	M/BF-1650/2	95.459	769	TOM SCHAEFER	MYLAWYERTOM.COM	09/21
769	09/21	TOM SCHAEFER	MYLAWYERTOM.COM	92.727	M/G-2000/2	93.192	769	TOM SCHAEFER	MYLAWYERTOM.COM	09/21
769	09/21	TOM SCHAEFER	MYLAWYERTOM.COM	92.299	M/F-2000/2	94.072	769	TOM SCHAEFER	MYLAWYERTOM.COM	09/21
769	09/21	TOM SCHAEFER	MYLAWYERTOM.COM	94.683	M/BG-2000/2	93.824	769	TOM SCHAEFER	MYLAWYERTOM.COM	09/21
769	09/21	TOM SCHAEFER	MYLAWYERTOM.COM	95.202	M/BF-2000/2	96.015	769	TOM SCHAEFER	MYLAWYERTOM.COM	09/21
769	09/21	TOM SCHAEFER	MYLAWYERTOM.COM	94.727	M/G-3000/2	96.392	769	TOM SCHAEFER	MYLAWYERTOM.COM	09/21
769	09/21	TOM SCHAEFER	MYLAWYERTOM.COM	92.162	M/F-3000/2	94.372	769	TOM SCHAEFER	MYLAWYERTOM.COM	09/21
769	09/21	TOM SCHAEFER	MYLAWYERTOM.COM	95.550	M/BG-3000/2	94.035	769	TOM SCHAEFER	MYLAWYERTOM.COM	09/21
769	09/21	TOM SCHAEFER	MYLAWYERTOM.COM	92.189	M/BF-3000/2	93.418	769	TOM SCHAEFER	MYLAWYERTOM.COM	09/21
MODIFIED PARTIAL STREAMLINER										
547	08/18	DOUG BINDER	BINDER RACING	60.292	MPS/F-50/2	62.945	547	DOUG BINDER	BINDER RACING	08/18
72	07/19	PRENT MARRINER	LARGE TIME RACING	76.746	MPS/G-100/2	75.733	72	PRENT MARRINER	LARGE TIME RACING	07/19
					MPS/G-125/2	142.287	2222	SCOTT KOLB	SCOTT KOLB	08/09
924	08/21	TOM SCHAEFER	MYLAWYERTOM.COM	86.256	MPS/G-175/2	83.969	924	TOM SCHAEFER	MYLAWYERTOM.COM	08/21
924	08/21	TOM SCHAEFER	MYLAWYERTOM.COM	86.336	MPS/BG-175/2	84.667	924	TOM SCHAEFER	MYLAWYERTOM.COM	08/21
924	08/21	TOM SCHAEFER	MYLAWYERTOM.COM	85.294	MPS/BF-175/2	84.285	924	TOM SCHAEFER	MYLAWYERTOM.COM	08/21
721	09/21	RICHARD PROSSER JR	RPM LAND SPEED	97.483	MPS/G-250/2	98.281	721	RICHARD PROSSER JR	RPM LAND SPEED	09/21
721	09/21	RICHARD PROSSER JR	RPM LAND SPEED	89.380	MPS/F-250/2	92.451	721	RICHARD PROSSER JR	RPM LAND SPEED	09/21
721	09/21	RICHARD PROSSER JR	RPM LAND SPEED	93.730	MPS/BG-250/2	93.241	721	RICHARD PROSSER JR	RPM LAND SPEED	09/21
721	09/21	RICHARD PROSSER JR	RPM LAND SPEED	92.258	MPS/BF-250/2	93.461	721	RICHARD PROSSER JR	RPM LAND SPEED	09/21
769	07/21	TOM SCHAEFER	MYLAWYERTOM.COM	118.041	MPS/G-350/2	117.976	769	TOM SCHAEFER	MYLAWYERTOM.COM	07/21
769	07/21	TOM SCHAEFER	MYLAWYERTOM.COM	115.709	MPS/F-350/2	117.470	769	TOM SCHAEFER	MYLAWYERTOM.COM	07/21

7C

VEH #	DATE	DRIVER	TEAM	1.0	CLASS	1.5	VEH #	DRIVER	TEAM	DATE
769	07/21	TOM SCHAEFER	MYLAWYERTOM.COM	114.675	MPS/BG-350/2	115.294	769	TOM SCHAEFER	MYLAWYERTOM.COM	07/21
769	07/21	TOM SCHAEFER	MYLAWYERTOM.COM	110.046	MPS/BF-350/2	107.313	769	TOM SCHAEFER	MYLAWYERTOM.COM	07/21
769	07/21	TOM SCHAEFER	MYLAWYERTOM.COM	110.250	MPS/G-400/2	110.026	769	TOM SCHAEFER	MYLAWYERTOM.COM	07/21
769	07/21	TOM SCHAEFER	MYLAWYERTOM.COM	112.765	MPS/F-400/2	110.315	769	TOM SCHAEFER	MYLAWYERTOM.COM	07/21
769	07/21	TOM SCHAEFER	MYLAWYERTOM.COM	111.332	MPS/BG-400/2	112.871	769	TOM SCHAEFER	MYLAWYERTOM.COM	07/21
769	07/21	TOM SCHAEFER	MYLAWYERTOM.COM	112.218	MPS/BF-400/2	112.154	769	TOM SCHAEFER	MYLAWYERTOM.COM	07/21
769	07/21	TOM SCHAEFER	MYLAWYERTOM.COM	113.151	MPS/G-500/2	112.700	769	TOM SCHAEFER	MYLAWYERTOM.COM	07/21
769	07/21	TOM SCHAEFER	MYLAWYERTOM.COM	113.346	MPS/F-500/2	114.676	769	TOM SCHAEFER	MYLAWYERTOM.COM	07/21
769	07/21	TOM SCHAEFER	MYLAWYERTOM.COM	115.086	MPS/BG-500/2	113.543	769	TOM SCHAEFER	MYLAWYERTOM.COM	07/21
769	07/21	TOM SCHAEFER	MYLAWYERTOM.COM	115.178	MPS/BF-500/2	116.351	769	TOM SCHAEFER	MYLAWYERTOM.COM	07/21
769	07/21	TOM SCHAEFER	MYLAWYERTOM.COM	115.194	MPS/G-650/2	113.364	769	TOM SCHAEFER	MYLAWYERTOM.COM	07/21
769	07/21	TOM SCHAEFER	MYLAWYERTOM.COM	114.673	MPS/F-650/2	113.948	769	TOM SCHAEFER	MYLAWYERTOM.COM	07/21
769	07/21	TOM SCHAEFER	MYLAWYERTOM.COM	113.986	MPS/BG-650/2	115.835	769	TOM SCHAEFER	MYLAWYERTOM.COM	07/21
769	07/21	TOM SCHAEFER	MYLAWYERTOM.COM	93.795	MPS/BF-650/2	94.128	769	TOM SCHAEFER	MYLAWYERTOM.COM	07/21
9943	07/13	FRANK JOHN	FJ RACING	124.409	MPS/G-750/2	98.512	769	TOM SCHAEFER	MYLAWYERTOM.COM	08/21
9943	08/13	FRANK JOHN	FJ RACING	124.206	MPS/F-750/2	127.466	9943	FRANK JOHN	FJ RACING	08/13
769	08/21	TOM SCHAEFER	MYLAWYERTOM.COM	98.559	MPS/BG-750/2	100.139	769	TOM SCHAEFER	MYLAWYERTOM.COM	08/21
769	08/21	TOM SCHAEFER	MYLAWYERTOM.COM	97.263	MPS/BF-750/2	97.747	769	TOM SCHAEFER	MYLAWYERTOM.COM	08/21
9943	07/15	FRANK JOHN	FJ RACING	125.440	MPS/G-1000/2	105.497	769	TOM SCHAEFER	MYLAWYERTOM.COM	09/21
9943	04/15	FRANK JOHN	FJ RACING	100.588	MPS/F-1000/2	101.081	769	TOM SCHAEFER	MYLAWYERTOM.COM	09/21
769	09/21	TOM SCHAEFER	MYLAWYERTOM.COM	101.106	MPS/BG-1000/2	103.833	769	TOM SCHAEFER	MYLAWYERTOM.COM	09/21
769	09/21	TOM SCHAEFER	MYLAWYERTOM.COM	106.419	MPS/BF-1000/2	106.785	769	TOM SCHAEFER	MYLAWYERTOM.COM	09/21
769	09/21	TOM SCHAEFER	MYLAWYERTOM.COM	107.037	MPS/G-1350/2	107.740	769	TOM SCHAEFER	MYLAWYERTOM.COM	09/21
769	09/21	TOM SCHAEFER	MYLAWYERTOM.COM	108.371	MPS/F-1350/2	105.963	769	TOM SCHAEFER	MYLAWYERTOM.COM	09/21
769	09/21	TOM SCHAEFER	MYLAWYERTOM.COM	105.694	MPS/BG-1350/2	105.914	769	TOM SCHAEFER	MYLAWYERTOM.COM	09/21
769	09/21	TOM SCHAEFER	MYLAWYERTOM.COM	102.521	MPS/BF-1350/2	103.286	769	TOM SCHAEFER	MYLAWYERTOM.COM	09/21
769	09/21	TOM SCHAEFER	MYLAWYERTOM.COM	101.244	MPS/G-1650/2	103.938	769	TOM SCHAEFER	MYLAWYERTOM.COM	09/21
769	09/21	TOM SCHAEFER	MYLAWYERTOM.COM	99.848	MPS/F-1650/2	101.184	769	TOM SCHAEFER	MYLAWYERTOM.COM	09/21
769	09/21	TOM SCHAEFER	MYLAWYERTOM.COM	102.071	MPS/BG-1650/2	102.527	769	TOM SCHAEFER	MYLAWYERTOM.COM	09/21
769	09/21	TOM SCHAEFER	MYLAWYERTOM.COM	101.116	MPS/BF-1650/2	101.881	769	TOM SCHAEFER	MYLAWYERTOM.COM	09/21
769	09/21	TOM SCHAEFER	MYLAWYERTOM.COM	100.018	MPS/G-2000/2	102.692	769	TOM SCHAEFER	MYLAWYERTOM.COM	09/21
769	09/21	TOM SCHAEFER	MYLAWYERTOM.COM	98.749	MPS/F-2000/2	101.037	769	TOM SCHAEFER	MYLAWYERTOM.COM	09/21
769	09/21	TOM SCHAEFER	MYLAWYERTOM.COM	101.308	MPS/BG-2000/2	105.577	769	TOM SCHAEFER	MYLAWYERTOM.COM	09/21
769	09/21	TOM SCHAEFER	MYLAWYERTOM.COM	92.076	MPS/BF-2000/2	94.773	769	TOM SCHAEFER	MYLAWYERTOM.COM	09/21
769	09/21	TOM SCHAEFER	MYLAWYERTOM.COM	94.868	MPS/G-3000/2	97.184	769	TOM SCHAEFER	MYLAWYERTOM.COM	09/21
769	09/21	TOM SCHAEFER	MYLAWYERTOM.COM	95.482	MPS/F-3000/2	98.003	769	TOM SCHAEFER	MYLAWYERTOM.COM	09/21
769	09/21	TOM SCHAEFER	MYLAWYERTOM.COM	95.194	MPS/BG-3000/2	96.081	769	TOM SCHAEFER	MYLAWYERTOM.COM	09/21
769	09/21	TOM SCHAEFER	MYLAWYERTOM.COM	95.638	MPS/BF-3000/2	95.716	769	TOM SCHAEFER	MYLAWYERTOM.COM	09/21
ALTERED										
4712	09/17	BRENDAN MALONE	BRASS RING RACING	68.641	A/G-50/2	67.367	4712	BRENDAN MALONE	BRASS RING RACING	09/17
4712	09/18	BRENDAN MALONE	BRASS RING RACING	64.404	A/BG-50/2	63.978	4712	BRENDAN MALONE	BRASS RING RACING	09/18
					A/G-175/2	92.583	1401	SETH FRINK	STERLING HILL GANG	08/09
					A/F-175/2	81.411	1401	SETH FRINK	STERLING HILL GANG	09/11
					A/BG-175/2	72.575	1401	SETH FRINK	STERLING HILL GANG	08/09

VEH #	DATE	DRIVER	TEAM	1.0	CLASS	1.5	VEH #	DRIVER	TEAM	DATE	
1908	07/13	JESSE MICHAUD	MICHAUD RACING	119.081	A/G-250/2	101.735	1908	JESSE MICHAUD	MICHAUD RACING	07/11	
1401	09/15	SETH FRINK	STERLING HILL GANG	83.879	A/BG-250/2	82.483	1401	SETH FRINK	STERLING HILL GANG	09/15	
L121	07/18	JOSHUA BATE	MOSQUITO CONTROL	123.084	A/G-500/2	119.507	9383	ERIC PAQUETTE	DAS PERFORMANCE	08/10	
ALTERED PARTIAL STREAMLINER											
4712	07/19	BRENDAN MALONE	MALONE FAMILY RACING	66.048	APS/G-50/2	65.934	4712	BRENDAN MALONE	MALONE FAMILY RACING	07/19	
481	07/19	JONAH BARRETT	MALONE FAMILY RACING	70.015	APS/BG-50/2	69.543	4712	JONAH BARRETT	MALONE FAMILY RACING	07/19	
481	09/18	PAUL KOEHLER	GEERHED RACING	108.196	APS/G-125/2	113.237	481	PAUL KOEHLER	GEERHED RACING	07/11	
1401	07/16	SETH FRINK	STERLING HILL GANG	82.695	APS/BG-175/2	67.876	1401	SETH FRINK	STERLING HILL GANG	08/09	
860	09/21	VIN BORBONE	BORBONE RACING	125.449	APS/BF-250/2	65.882	1401	SETH FRINK	STERLING HILL GANG	07/16	
SIDECAR											
OPEN											
7400	07/12	SETH FRINK	STERLING HILL GANG	93.113	S/G-500/2	91.242	7400	SETH FRINK	STERLING HILL GANG	07/12	
STREAMLINER											
OPEN											
246	08/19	CYRIL VISOVSKY	DHARMA RACING	155.932	PP/PT-1000/4	159.822	246	CYRIL VISOVSKY	DHARMA RACING	08/19	
500	08/19	SHANE SCOTT	SEQUOIA NATURAL	171.584	PP/PT-1350/4	174.155	500	SHANE SCOTT	SEQUOIA NATURAL	08/19	
PRODUCTION											
L120	08/18	JOSHUA BATE	MOSQUITO CONTROL	84.581	P/PT-250/4	84.651	L120	JOSHUA BATE	MOSQUITO CONTROL	08/18	
88	09/20	TOM SCHAEFER	MYLAWYERTOM.COM	101.902	P/PT-350/4	104.673	88	TOM SCHAEFER	MYLAWYERTOM.COM	09/20	
88	09/20	TOM SCHAEFER	MYLAWYERTOM.COM	104.141	P/BPT-350/4	108.735	88	TOM SCHAEFER	MYLAWYERTOM.COM	09/20	
88	09/20	TOM SCHAEFER	MYLAWYERTOM.COM	106.063	P/PT-400/4	104.501	88	TOM SCHAEFER	MYLAWYERTOM.COM	09/20	
88	09/20	TOM SCHAEFER	MYLAWYERTOM.COM	106.348	P/BPT-400/4	105.598	88	TOM SCHAEFER	MYLAWYERTOM.COM	09/20	
88	09/20	TOM SCHAEFER	MYLAWYERTOM.COM	104.282	P/PT-500/4	103.944	88	TOM SCHAEFER	MYLAWYERTOM.COM	09/20	
88	09/20	TOM SCHAEFER	MYLAWYERTOM.COM	104.998	P/BPT-500/4	103.970	88	TOM SCHAEFER	MYLAWYERTOM.COM	09/20	
88	09/20	TOM SCHAEFER	MYLAWYERTOM.COM	104.761	P/PT-650/4	103.801	88	TOM SCHAEFER	MYLAWYERTOM.COM	09/20	
88	09/20	TOM SCHAEFER	MYLAWYERTOM.COM	105.285	P/BPT-650/4	105.981	88	TOM SCHAEFER	MYLAWYERTOM.COM	09/20	
8857	09/15	ED HOLMAN	HOLMAN RACING	142.628	P/PT-750/4	147.436	8857	ED HOLMAN	HOLMAN RACING	09/15	
1906	08/14	JESSE MICHAUD	SHIT LEOPARD RACING	164.328	P/PT-1000/4	168.916	1906	JESSE MICHAUD	SHIT LEOPARD RACING	08/14	
1692	09/20	TOM SCHAEFER	MYLAWYERTOM.COM	170.745	P/BPT-1000/4	171.955	1692	TOM SCHAEFER	MYLAWYERTOM.COM	09/20	
1692	09/20	TOM SCHAEFER	MYLAWYERTOM.COM	171.977	P/PT-1350/4	171.692	1692	TOM SCHAEFER	MYLAWYERTOM.COM	09/20	

TWINS CATEGORY

PURE PRODUCTION

246	08/19	CYRIL VISOVSKY	DHARMA RACING
500	08/19	SHANE SCOTT	SEQUOIA NATURAL

PRODUCTION

L120	08/18	JOSHUA BATE	MOSQUITO CONTROL
88	09/20	TOM SCHAEFER	MYLAWYERTOM.COM
88	09/20	TOM SCHAEFER	MYLAWYERTOM.COM
88	09/20	TOM SCHAEFER	MYLAWYERTOM.COM
88	09/20	TOM SCHAEFER	MYLAWYERTOM.COM
88	09/20	TOM SCHAEFER	MYLAWYERTOM.COM
88	09/20	TOM SCHAEFER	MYLAWYERTOM.COM
88	09/20	TOM SCHAEFER	MYLAWYERTOM.COM
88	09/20	TOM SCHAEFER	MYLAWYERTOM.COM
8857	09/15	ED HOLMAN	HOLMAN RACING
1906	08/14	JESSE MICHAUD	SHIT LEOPARD RACING
1692	09/20	TOM SCHAEFER	MYLAWYERTOM.COM
1692	09/20	TOM SCHAEFER	MYLAWYERTOM.COM

VEH #	DATE	DRIVER	TEAM	CLASS	1.0	1.5	VEH #	DRIVER	TEAM	DATE
1692	09/20	TOM SCHAEFER	MYLAWVERTOM.COM				1692	TOM SCHAEFER	MYLAWVERTOM.COM	09/20
1692	09/20	TOM SCHAEFER	MYLAWVERTOM.COM	P/BPT-1350/4	171.052	173.049	1692	TOM SCHAEFER	MYLAWVERTOM.COM	09/20
1692	09/20	TOM SCHAEFER	MYLAWVERTOM.COM	P/PT-1650/4	172.974	171.953	1692	TOM SCHAEFER	MYLAWVERTOM.COM	09/20
1692	09/20	TOM SCHAEFER	MYLAWVERTOM.COM	P/BPT-1650/4	171.252	171.422	1692	TOM SCHAEFER	MYLAWVERTOM.COM	09/20
1692	09/20	TOM SCHAEFER	MYLAWVERTOM.COM	P/PT-2000/4	172.485	173.270	1692	TOM SCHAEFER	MYLAWVERTOM.COM	09/20
1692	09/20	TOM SCHAEFER	MYLAWVERTOM.COM	P/BPT-2000/4	170.880	171.273	1692	TOM SCHAEFER	MYLAWVERTOM.COM	09/20
1692	09/20	TOM SCHAEFER	MYLAWVERTOM.COM	P/PT-3000/4	172.373	172.373	1692	TOM SCHAEFER	MYLAWVERTOM.COM	09/20
1692	09/20	TOM SCHAEFER	MYLAWVERTOM.COM	P/BPT-3000/4	168.584	172.139	1692	TOM SCHAEFER	MYLAWVERTOM.COM	09/20
MODIFIED										
2469	09/18	KRIS POULIN	#TEAM469	M/TG-350/4	106.010	106.983	2469	KRIS POULIN	#TEAM469	09/18
88	09/20	TOM SCHAEFER	MYLAWVERTOM.COM	M/TF-350/4	100.684	101.926	88	TOM SCHAEFER	MYLAWVERTOM.COM	09/20
88	09/20	TOM SCHAEFER	MYLAWVERTOM.COM	M/TBG-350/4	103.330	104.087	88	TOM SCHAEFER	MYLAWVERTOM.COM	09/20
88	09/20	TOM SCHAEFER	MYLAWVERTOM.COM	M/TBF-350/4	101.175	103.367	88	TOM SCHAEFER	MYLAWVERTOM.COM	09/20
2469	09/18	KRIS POULIN	#TEAM469	M/TG-400/4	107.110	109.243	2469	KRIS POULIN	#TEAM469	09/18
88	09/20	TOM SCHAEFER	MYLAWVERTOM.COM	M/TF-400/4	101.596	103.631	88	TOM SCHAEFER	MYLAWVERTOM.COM	09/20
88	09/20	TOM SCHAEFER	MYLAWVERTOM.COM	M/TBG-400/4	103.163	103.632	88	TOM SCHAEFER	MYLAWVERTOM.COM	09/20
88	09/20	TOM SCHAEFER	MYLAWVERTOM.COM	M/TBF-400/4	102.397	103.617	88	TOM SCHAEFER	MYLAWVERTOM.COM	09/20
2469	09/18	KRIS POULIN	#TEAM469	M/TG-500/4	110.043	110.233	2469	KRIS POULIN	#TEAM469	09/18
88	09/20	TOM SCHAEFER	MYLAWVERTOM.COM	M/TF-500/4	103.020	104.364	88	TOM SCHAEFER	MYLAWVERTOM.COM	09/20
88	09/20	TOM SCHAEFER	MYLAWVERTOM.COM	M/TBG-500/4	104.667	105.505	88	TOM SCHAEFER	MYLAWVERTOM.COM	09/20
88	09/20	TOM SCHAEFER	MYLAWVERTOM.COM	M/TBF-500/4	104.997	107.032	88	TOM SCHAEFER	MYLAWVERTOM.COM	09/20
88	09/20	TOM SCHAEFER	MYLAWVERTOM.COM	M/TG-650/4	106.085	105.742	88	TOM SCHAEFER	MYLAWVERTOM.COM	09/20
88	09/20	TOM SCHAEFER	MYLAWVERTOM.COM	M/TF-650/4	100.520	100.219	88	TOM SCHAEFER	MYLAWVERTOM.COM	09/20
88	09/20	TOM SCHAEFER	MYLAWVERTOM.COM	M/TBG-650/4	100.766	99.114	88	TOM SCHAEFER	MYLAWVERTOM.COM	09/20
88	09/20	TOM SCHAEFER	MYLAWVERTOM.COM	M/TBF-650/4	99.770	100.136	88	TOM SCHAEFER	MYLAWVERTOM.COM	09/20
88	09/20	TOM SCHAEFER	MYLAWVERTOM.COM	M/TG-750/4	101.001	102.240	88	TOM SCHAEFER	MYLAWVERTOM.COM	09/20
88	09/20	TOM SCHAEFER	MYLAWVERTOM.COM	M/TF-750/4	102.751	101.458	88	TOM SCHAEFER	MYLAWVERTOM.COM	09/20
88	09/20	TOM SCHAEFER	MYLAWVERTOM.COM	M/TBG-750/4	102.153	102.288	88	TOM SCHAEFER	MYLAWVERTOM.COM	09/20
88	09/20	TOM SCHAEFER	MYLAWVERTOM.COM	M/TBF-750/4	102.018	102.973	88	TOM SCHAEFER	MYLAWVERTOM.COM	09/20
212	09/20	MIKE MAITEM	#DREAMINGOFSPED	M/TG-1000/4	167.306	169.807	212	MIKE MAITEM	#DREAMINGOFSPED	09/20
212	07/22	MIKE MAITEM	#DREAMINGOFSPED	M/TF-1000/4	169.929	174.171	212	MIKE MAITEM	#DREAMINGOFSPED	07/22
1692	07/21	TOM SCHAEFER	MYLAWVERTOM.COM	M/TBG-1000/4	166.682	171.430	1692	TOM SCHAEFER	MYLAWVERTOM.COM	07/21
1692	07/21	TOM SCHAEFER	MYLAWVERTOM.COM	M/TBF-1000/4	153.201	169.201	1692	TOM SCHAEFER	MYLAWVERTOM.COM	07/21
1692	07/21	TOM SCHAEFER	MYLAWVERTOM.COM	M/TG-1350/4	158.438	161.767	1692	TOM SCHAEFER	MYLAWVERTOM.COM	07/21
1692	07/21	TOM SCHAEFER	MYLAWVERTOM.COM	M/TF-1350/4	165.788	167.592	1692	TOM SCHAEFER	MYLAWVERTOM.COM	07/21
1692	07/21	TOM SCHAEFER	MYLAWVERTOM.COM	M/TBG-1350/4	165.788	167.592	1692	TOM SCHAEFER	MYLAWVERTOM.COM	07/21
1692	07/21	TOM SCHAEFER	MYLAWVERTOM.COM	M/TBF-1350/4	163.175	165.497	1692	TOM SCHAEFER	MYLAWVERTOM.COM	07/21
1692	07/21	TOM SCHAEFER	MYLAWVERTOM.COM	M/TG-1650/4	167.140	169.682	1692	TOM SCHAEFER	MYLAWVERTOM.COM	07/21
1692	07/21	TOM SCHAEFER	MYLAWVERTOM.COM	M/TF-1650/4	166.818	167.448	1692	TOM SCHAEFER	MYLAWVERTOM.COM	07/21
1692	07/21	TOM SCHAEFER	MYLAWVERTOM.COM	M/TBG-1650/4	157.097	166.431	1692	TOM SCHAEFER	MYLAWVERTOM.COM	07/21
1692	07/21	TOM SCHAEFER	MYLAWVERTOM.COM	M/TBF-1650/4	163.489	164.699	1692	TOM SCHAEFER	MYLAWVERTOM.COM	07/21
1692	07/21	TOM SCHAEFER	MYLAWVERTOM.COM	M/TG-2000/4	153.052	161.442	1692	TOM SCHAEFER	MYLAWVERTOM.COM	07/21
1692	07/21	TOM SCHAEFER	MYLAWVERTOM.COM	M/TF-2000/4	163.694	163.230	1692	TOM SCHAEFER	MYLAWVERTOM.COM	07/21
1692	07/21	TOM SCHAEFER	MYLAWVERTOM.COM	M/TBG-2000/4	164.033	165.844	1692	TOM SCHAEFER	MYLAWVERTOM.COM	07/21
1692	07/21	TOM SCHAEFER	MYLAWVERTOM.COM	M/TBF-2000/4	154.411	150.621	1692	TOM SCHAEFER	MYLAWVERTOM.COM	07/21

VEH #	DATE	DRIVER	TEAM	1.0	CLASS	1.5	VEH #	DRIVER	TEAM	DATE
1692	07/21	TOM SCHAEFER	MYLAWYERTOM.COM	151.242	M/JTG-3000/4	155.063	1692	TOM SCHAEFER	MYLAWYERTOM.COM	07/21
1692	07/21	TOM SCHAEFER	MYLAWYERTOM.COM	148.305	M/JTG-3000/4	149.204	1692	TOM SCHAEFER	MYLAWYERTOM.COM	07/21
63	09/21	TOM SCHAEFER	MYLAWYERTOM.COM	153.537	M/TBG-3000/4	155.217	63	TOM SCHAEFER	MYLAWYERTOM.COM	09/21
63	09/21	TOM SCHAEFER	MYLAWYERTOM.COM	151.013	M/TBF-3000/4	152.979	63	TOM SCHAEFER	MYLAWYERTOM.COM	09/21
MODIFIED PARTIAL STREAMLINER										
9884	05/16	FRANK STYDUHAR	KRYPTON RACING	90.067	MPS/TG-175/4	87.898	9884	FRANK STYDUHAR	KRYPTON RACING	05/16
9884	08/14	TOM CROMPTON	KRYPTON RACING	86.167	MPS/TF-175/4	85.835	9884	TOM CROMPTON	KRYPTON RACING	08/14
312	07/16	GREG NEAL	TLN MOTORSPORTS	112.295	MPS/TG-250/4	112.216	312	GREG NEAL	TLN MOTORSPORTS	07/16
312	07/16	GREG NEAL	TLN MOTORSPORTS	109.778	MPS/TF-250/4	112.707	312	GREG NEAL	TLN MOTORSPORTS	07/16
312	07/16	GREG NEAL	TLN MOTORSPORTS	111.626	MPS/TBG-250/4	112.767	312	GREG NEAL	TLN MOTORSPORTS	07/16
312	07/16	GREG NEAL	TLN MOTORSPORTS	113.560	MPS/TBF-250/4	114.006	312	GREG NEAL	TLN MOTORSPORTS	07/16
9635	05/16	GREG NEAL	TLN MOTORSPORTS	109.567	MPS/TG-350/4	110.640	9635	GREG NEAL	TLN MOTORSPORTS	05/16
9635	05/16	GREG NEAL	TLN MOTORSPORTS	109.740	MPS/TF-350/4	111.007	9635	GREG NEAL	TLN MOTORSPORTS	05/16
9635	05/16	GREG NEAL	TLN MOTORSPORTS	112.158	MPS/TBG-350/4	112.186	9635	GREG NEAL	TLN MOTORSPORTS	05/16
9635	05/16	GREG NEAL	TLN MOTORSPORTS	111.507	MPS/TBF-350/4	111.485	9635	GREG NEAL	TLN MOTORSPORTS	05/16
9635	05/16	GREG NEAL	TLN MOTORSPORTS	110.896	MPS/TG-400/4	111.004	9635	GREG NEAL	TLN MOTORSPORTS	05/16
9635	05/16	GREG NEAL	TLN MOTORSPORTS	110.896	MPS/TF-400/4	110.591	9635	GREG NEAL	TLN MOTORSPORTS	05/16
312	07/16	GREG NEAL	TLN MOTORSPORTS	113.573	MPS/TBG-400/4	116.458	312	GREG NEAL	TLN MOTORSPORTS	07/16
312	07/16	GREG NEAL	TLN MOTORSPORTS	115.927	MPS/TBF-400/4	115.058	312	GREG NEAL	TLN MOTORSPORTS	07/16
312	07/16	GREG NEAL	TLN MOTORSPORTS	106.277	MPS/TG-500/4	105.945	312	GREG NEAL	TLN MOTORSPORTS	07/16
312	07/16	GREG NEAL	TLN MOTORSPORTS	106.394	MPS/TF-500/4	106.777	312	GREG NEAL	TLN MOTORSPORTS	07/16
312	07/16	GREG NEAL	TLN MOTORSPORTS	105.592	MPS/TBG-500/4	104.442	88	TOM SCHAEFER	MYLAWYERTOM.COM	09/20
312	07/16	GREG NEAL	TLN MOTORSPORTS	106.256	MPS/TBF-500/4	107.495	312	GREG NEAL	TLN MOTORSPORTS	07/16
211	07/18	MIKE MAITEM	#DREAMINGOF SPEED	122.738	MPS/TG-650/4	123.712	211	MIKE MAITEM	#DREAMINGOF SPEED	07/18
211	07/18	MIKE MAITEM	#DREAMINGOF SPEED	123.149	MPS/TF-650/4	122.320	211	MIKE MAITEM	#DREAMINGOF SPEED	07/18
312	07/16	GREG NEAL	TLN MOTORSPORTS	108.244	MPS/TBG-650/4	108.405	312	GREG NEAL	TLN MOTORSPORTS	07/16
312	07/16	GREG NEAL	TLN MOTORSPORTS	107.736	MPS/TBF-650/4	108.333	312	GREG NEAL	TLN MOTORSPORTS	07/16
8857	09/15	ED HOLMAN	HOLMAN RACING	143.688	MPS/TG-750/4	148.615	8857	ED HOLMAN	HOLMAN RACING	09/15
312	07/16	GREG NEAL	TLN MOTORSPORTS	107.964	MPS/TF-750/4	108.527	312	GREG NEAL	TLN MOTORSPORTS	07/16
312	07/16	GREG NEAL	TLN MOTORSPORTS	107.714	MPS/TBG-750/4	109.060	312	GREG NEAL	TLN MOTORSPORTS	07/16
312	07/16	GREG NEAL	TLN MOTORSPORTS	107.300	MPS/TBF-750/4	108.083	312	GREG NEAL	TLN MOTORSPORTS	07/16
9935	07/17	DAVID AURAND	I NEED COFFEE	170.787	MPS/TG-1000/4	171.040	9935	DAVID AURAND	I NEED COFFEE	07/17
1692	07/21	TOM SCHAEFER	MYLAWYERTOM.COM	173.393	MPS/TF-1000/4	171.882	1692	TOM SCHAEFER	MYLAWYERTOM.COM	07/21
1692	07/21	TOM SCHAEFER	MYLAWYERTOM.COM	172.278	MPS/TBG-1000/4	172.846	1692	TOM SCHAEFER	MYLAWYERTOM.COM	07/21
1692	07/21	TOM SCHAEFER	MYLAWYERTOM.COM	172.655	MPS/TBF-1000/4	171.870	1692	TOM SCHAEFER	MYLAWYERTOM.COM	07/21
1692	07/21	TOM SCHAEFER	MYLAWYERTOM.COM	171.503	MPS/TG-1350/4	171.638	1692	TOM SCHAEFER	MYLAWYERTOM.COM	07/21
1692	07/21	TOM SCHAEFER	MYLAWYERTOM.COM	171.075	MPS/TF-1350/4	171.996	1692	TOM SCHAEFER	MYLAWYERTOM.COM	07/21
1692	07/21	TOM SCHAEFER	MYLAWYERTOM.COM	174.313	MPS/TBG-1350/4	171.379	1692	TOM SCHAEFER	MYLAWYERTOM.COM	07/21
1692	07/21	TOM SCHAEFER	MYLAWYERTOM.COM	174.262	MPS/TBF-1350/4	171.875	1692	TOM SCHAEFER	MYLAWYERTOM.COM	07/21
1692	07/21	TOM SCHAEFER	MYLAWYERTOM.COM	171.283	MPS/TG-1650/4	171.948	1692	TOM SCHAEFER	MYLAWYERTOM.COM	07/21
1692	07/21	TOM SCHAEFER	MYLAWYERTOM.COM	171.450	MPS/TF-1650/4	172.377	1692	TOM SCHAEFER	MYLAWYERTOM.COM	07/21
1692	07/21	TOM SCHAEFER	MYLAWYERTOM.COM	171.208	MPS/TBG-1650/4	171.680	1692	TOM SCHAEFER	MYLAWYERTOM.COM	07/21
1692	07/21	TOM SCHAEFER	MYLAWYERTOM.COM	172.358	MPS/TBF-1650/4	171.896	1692	TOM SCHAEFER	MYLAWYERTOM.COM	07/21
1692	07/21	TOM SCHAEFER	MYLAWYERTOM.COM	174.160	MPS/TG-2000/4	173.067	1692	TOM SCHAEFER	MYLAWYERTOM.COM	07/21

VEH #	DATE	DRIVER	TEAM	1.0	CLASS	VEH #	DRIVER	TEAM	DATE
1692	07/21	TOM SCHAEFER	MYLAWVERTOM.COM	174.812	MPS/TF-2000/4	1692	TOM SCHAEFER	MYLAWVERTOM.COM	07/21
1692	07/21	TOM SCHAEFER	MYLAWVERTOM.COM	174.325	MPS/TBG-2000/4	1692	TOM SCHAEFER	MYLAWVERTOM.COM	07/21
1692	07/21	TOM SCHAEFER	MYLAWVERTOM.COM	172.183	MPS/TBF-2000/4	1692	TOM SCHAEFER	MYLAWVERTOM.COM	07/21
1837	09/20	JAMES DUNN	TEAM JIMISH	173.348	MPS/TG-3000/4	1692	TOM SCHAEFER	MYLAWVERTOM.COM	07/21
1692	07/21	TOM SCHAEFER	MYLAWVERTOM.COM	172.529	MPS/TBF-3000/4	1692	TOM SCHAEFER	MYLAWVERTOM.COM	07/21
1692	07/21	TOM SCHAEFER	MYLAWVERTOM.COM	174.622	MPS/TF-3000/4	1692	TOM SCHAEFER	MYLAWVERTOM.COM	07/21
1692	07/21	TOM SCHAEFER	MYLAWVERTOM.COM	173.791	MPS/TBF-3000/4	1692	TOM SCHAEFER	MYLAWVERTOM.COM	07/21
ALTERED									
9616	08/19	STACY ROBEY	FAIRWAY MOTORSPORTS	63.599	A/TF-250/4	9616	STACY ROBEY	FAIRWAY MOTORSPORTS	08/19
312	09/16	GREG NEAL	TLN MOTORSPORTS	90.008	A/TF-350/4	312	GREG NEAL	TLN MOTORSPORTS	09/16
312	09/16	GREG NEAL	TLN MOTORSPORTS	90.962	A/TF-350/4	312	GREG NEAL	TLN MOTORSPORTS	09/16
312	09/16	GREG NEAL	TLN MOTORSPORTS	94.898	A/TBG-350/4	312	GREG NEAL	TLN MOTORSPORTS	09/16
312	09/16	GREG NEAL	TLN MOTORSPORTS	95.162	A/TBF-350/4	312	GREG NEAL	TLN MOTORSPORTS	09/16
1908	05/16	JESSE MICHAUD	SUNNYVALE RACING	99.503	A/TG-400/4	1908	JESSE MICHAUD	SUNNYVALE RACING	05/16
312	09/16	GREG NEAL	TLN MOTORSPORTS	95.102	A/TF-400/4	312	GREG NEAL	TLN MOTORSPORTS	09/16
312	09/16	GREG NEAL	TLN MOTORSPORTS	94.826	A/TBG-400/4	312	GREG NEAL	TLN MOTORSPORTS	09/16
312	09/16	GREG NEAL	TLN MOTORSPORTS	95.531	A/TBF-400/4	312	GREG NEAL	TLN MOTORSPORTS	09/16
312	09/16	GREG NEAL	TLN MOTORSPORTS	92.678	A/TG-500/4	312	GREG NEAL	TLN MOTORSPORTS	09/16
312	09/16	GREG NEAL	TLN MOTORSPORTS	94.625	A/TF-500/4	312	GREG NEAL	TLN MOTORSPORTS	09/16
312	09/16	GREG NEAL	TLN MOTORSPORTS	93.028	A/TBG-500/4	312	GREG NEAL	TLN MOTORSPORTS	09/16
780	08/19	KYLE MALINKY	LOW BROW RACING	132.761	A/TG-650/4	780	KYLE MALINKY	LOW BROW RACING	08/19
312	09/16	GREG NEAL	TLN MOTORSPORTS	101.264	A/TF-650/4	312	GREG NEAL	TLN MOTORSPORTS	09/16
312	09/16	GREG NEAL	TLN MOTORSPORTS	102.283	A/TBG-650/4	312	GREG NEAL	TLN MOTORSPORTS	09/16
4836	04/15	CLIFF DALY	FAIRWAY MOTORSPORTS	116.650	A/TBF-750/4	4836	CLIFF DALY	FAIRWAY MOTORSPORTS	04/15
9216	07/15	JESSE MICHAUD	SUNNYVALE RACING	143.381	A/TG-1000/4	9216	JANIE DALY	FAIRWAY MOTORSPORTS	07/22
9216	07/22	JANIE DALY	FAIRWAY MOTORSPORTS	130.890	A/TF-1000/4	9216	JANIE DALY	FAIRWAY MOTORSPORTS	07/22
9216	07/16	JOSEPH DALY	FAIRWAY MOTORSPORTS	127.519	A/TBG-1000/4	9216	JOSEPH DALY	FAIRWAY MOTORSPORTS	07/16
9216	07/16	JOSEPH DALY	FAIRWAY MOTORSPORTS	141.056	A/TG-1350/4	9216	JOSEPH DALY	FAIRWAY MOTORSPORTS	07/16
74	07/18	MICHAEL WITT	GRAY GHOST II PROJECT	173.684	A/TG-1650/4	74	MICHAEL WITT	GRAY GHOST II PROJECT	07/18
74	07/18	MICHAEL WITT	GRAY GHOST II PROJECT	171.906	A/TF-1650/4	74	MICHAEL WITT	GRAY GHOST II PROJECT	07/18
74	07/18	MICHAEL WITT	GRAY GHOST II PROJECT	170.224	A/TBF-1650/4	74	MICHAEL WITT	GRAY GHOST II PROJECT	07/18
259	07/22	MIKE YURKO	YURKO RACING	175.595	A/TG-2000/4	259	MIKE YURKO	YURKO RACING	07/22
259	07/18	MIKE YURKO	YURKO RACING	169.960	A/TF-2000/4	259	MIKE YURKO	YURKO RACING	07/19
259	07/22	MIKE YURKO	YURKO RACING	173.011	A/TBF-2000/4	259	MIKE YURKO	YURKO RACING	07/22
259	07/19	MIKE YURKO	YURKO RACING	174.388	A/TG-3000/4	259	MIKE YURKO	YURKO RACING	07/22
259	07/22	MIKE YURKO	YURKO RACING	166.054	A/TF-3000/4	259	MIKE YURKO	YURKO RACING	07/22
ALTERED PARTIAL STREAMLINER									
312	07/16	GREG NEAL	TLN MOTORSPORTS	113.384	APS/TG-250/4	312	GREG NEAL	TLN MOTORSPORTS	07/16
9635	05/16	GREG NEAL	TLN MOTORSPORTS	110.689	APS/TF-250/4	9635	GREG NEAL	TLN MOTORSPORTS	05/16
312	07/16	GREG NEAL	TLN MOTORSPORTS	106.546	APS/TBG-250/4	312	GREG NEAL	TLN MOTORSPORTS	07/16
9635	05/16	GREG NEAL	TLN MOTORSPORTS	110.184	APS/TBF-250/4	9635	GREG NEAL	TLN MOTORSPORTS	05/16
9635	05/16	GREG NEAL	TLN MOTORSPORTS	109.612	APS/TG-350/4	9635	GREG NEAL	TLN MOTORSPORTS	05/16
9635	05/16	GREG NEAL	TLN MOTORSPORTS	105.496	APS/TF-350/4	9635	GREG NEAL	TLN MOTORSPORTS	05/16

VEH #	DATE	DRIVER	TEAM	1.0	CLASS	1.5	VEH #	DRIVER	TEAM	DATE
9635	05/16	GREG NEAL	TLN MOTORSPORTS	105.494	AP5/TBG-350/4	105.902	9635	GREG NEAL	TLN MOTORSPORTS	05/16
9635	05/16	GREG NEAL	TLN MOTORSPORTS	108.532	AP5/TBF-350/4	110.895	9635	GREG NEAL	TLN MOTORSPORTS	05/16
9635	05/16	GREG NEAL	TLN MOTORSPORTS	109.473	AP5/TG-400/4	111.075	9635	GREG NEAL	TLN MOTORSPORTS	05/16
9635	05/16	GREG NEAL	TLN MOTORSPORTS	110.078	AP5/TF-400/4	112.417	9635	GREG NEAL	TLN MOTORSPORTS	05/16
9635	05/16	GREG NEAL	TLN MOTORSPORTS	111.774	AP5/TBG-400/4	67.922	9635	GREG NEAL	TLN MOTORSPORTS	05/16
9635	05/16	GREG NEAL	TLN MOTORSPORTS	111.004	AP5/TBF-400/4	112.258	9635	GREG NEAL	TLN MOTORSPORTS	05/16
312	07/16	GREG NEAL	TLN MOTORSPORTS	104.606	AP5/TG-500/4	105.761	312	GREG NEAL	TLN MOTORSPORTS	07/16
312	07/16	GREG NEAL	TLN MOTORSPORTS	104.106	AP5/TF-500/4	104.560	312	GREG NEAL	TLN MOTORSPORTS	07/16
312	07/16	GREG NEAL	TLN MOTORSPORTS	103.859	AP5/TBG-500/4	104.119	312	GREG NEAL	TLN MOTORSPORTS	07/16
312	07/16	GREG NEAL	TLN MOTORSPORTS	104.622	AP5/TBF-500/4	104.961	312	GREG NEAL	TLN MOTORSPORTS	07/16
312	07/16	GREG NEAL	TLN MOTORSPORTS	104.653	AP5/TG-650/4	106.128	312	GREG NEAL	TLN MOTORSPORTS	07/16
312	07/16	GREG NEAL	TLN MOTORSPORTS	105.171	AP5/TF-650/4	105.341	312	GREG NEAL	TLN MOTORSPORTS	07/16
312	07/16	GREG NEAL	TLN MOTORSPORTS	108.226	AP5/TBG-650/4	108.764	312	GREG NEAL	TLN MOTORSPORTS	07/16
312	07/16	GREG NEAL	TLN MOTORSPORTS	108.803	AP5/TBF-650/4	109.565	312	GREG NEAL	TLN MOTORSPORTS	07/16
312	07/16	GREG NEAL	TLN MOTORSPORTS	108.280	AP5/TG-750/4	109.009	312	GREG NEAL	TLN MOTORSPORTS	07/16
312	07/16	GREG NEAL	TLN MOTORSPORTS	109.193	AP5/TF-750/4	109.639	312	GREG NEAL	TLN MOTORSPORTS	07/16
312	07/16	GREG NEAL	TLN MOTORSPORTS	108.705	AP5/TBG-750/4	108.895	312	GREG NEAL	TLN MOTORSPORTS	07/16
312	07/16	GREG NEAL	TLN MOTORSPORTS	108.621	AP5/TBF-750/4	109.171	312	GREG NEAL	TLN MOTORSPORTS	07/16
9216	07/15	JESSE MICHAUD	SUNNYVALE RACING	145.050	AP5/TG-1000/4	148.358	9216	JESSE MICHAUD	SUNNYVALE RACING	07/15
1377	07/19	DOMENIC FERLISI	MISS VA VA VOOM	137.444	AP5/TF-1000/4	139.162	1377	DOMENIC FERLISI	MISS VA VA VOOM	07/19
312	07/16	GREG NEAL	TLN MOTORSPORTS	108.690	AP5/TBF-1000/4	109.635	312	GREG NEAL	TLN MOTORSPORTS	07/16

SIDECAR

1402	07/16	LLOYD FRINK SR	STERLING HILL GANG	111.268	SC/TG-1350/4	112.781	1402	LLOYD FRINK SR	STERLING HILL GANG	07/16
1402	07/16	LLOYD FRINK SR	STERLING HILL GANG	67.160	SC/TF-1350/4	93.726	1402	LLOYD FRINK SR	STERLING HILL GANG	07/16
1402	07/17	LLOYD FRINK SR	STERLING HILL GANG	92.406	P/PC-1350/4	92.462	1402	LLOYD FRINK SR	STERLING HILL GANG	07/17
1402	07/17	LLOYD FRINK SR	STERLING HILL GANG	99.790	SC/TBF-1350/4	97.785	1402	LLOYD FRINK SR	STERLING HILL GANG	07/17

CLASSIC CATEGORY

PURE PRODUCTION

PRODUCTION										
L162	08/14	TOM CROMPTON	KRYPTON RACING	41.944	P/PC-100	41.127	L162	TOM CROMPTON	KRYPTON RACING	08/14
L187	09/16	EDWIN KLIMEK	KLIMEK RACING	77.574	P/PC-350	78.579	L187	EDWIN KLIMEK	KLIMEK RACING	09/16
L13	09/17	LUC CANTIN	4G/C=R	62.342	P/PC-650	62.342	L13	LUC CANTIN	4G/C=R	09/17
1482	09/12	TOM DALY	FAIRWAY MOTORSPORTS	107.171	P/PC-750	108.166	1482	TOM DALY	FAIRWAY MOTORSPORTS	09/12
7447	07/17	ED ASHMEAD	LOOK OUT! RACING	94.666	M/CG-350	95.724	7447	ED ASHMEAD	LOOK OUT! RACING	07/17
L13	09/17	YVON CANTIN	4G/C=R	92.008	M/CF-400	79.900	1400	LLOYD W. FRINK IV	STERLING HILL GANG	07/12
L13	09/17	ODREE CANTIN	4G/C=R	77.409	M/CG-650	92.225	L13	YVON CANTIN	4G/C=R	09/17
9240	08/14	STEVE TOOTHAKER	BLACK KAT RACING	127.079	M/CF-750	78.092	L13	ODREE CANTIN	4G/C=R	09/17
9172	08/13	STEVE TOOTHAKER	BLACK KAT RACING	121.693	M/CG-750	128.321	9240	STEVE TOOTHAKER	BLACK KAT RACING	08/14
408	07/19	BILL BULLIS	BULLIS RACING	149.617	M/CF-1000	123.778	9172	STEVE TOOTHAKER	BLACK KAT RACING	08/13
740	07/13	JIM FISCHER	RILEY-FISCHER-WITT	144.094	M/CF-1350	150.481	408	BILL BULLIS	BULLIS RACING	07/19
						146.980	740	JIM FISCHER	RILEY-FISCHER-WITT	07/13

VEH #	DATE	DRIVER	TEAM	1.0	CLASS	1.5	VEH #	DRIVER	TEAM	DATE
740	07/13	JIM FISCHER	RILEY-FISCHER-WITT	142.198	M/CG-1350	145.601	740	JIM FISCHER	RILEY-FISCHER-WITT	07/13
9884	08/14	TOM CROMPTON	KRYPTON RACING	85.675	MPS/CF-175	88.648	9884	TOM CROMPTON	KRYPTON RACING	08/14
9884	08/14	TOM CROMPTON	KRYPTON RACING	89.923	MPS/CG-175	87.989	9884	TOM CROMPTON	KRYPTON RACING	08/14
9632	07/14	TOM CROMPTON	KRYPTON RACING	72.735	MPS/CF-350	72.773	9632	TOM CROMPTON	KRYPTON RACING	07/14
L187	08/18	EDWIN KLIMEK	KLIMEK RACING	94.017	MPS/CG-350	98.075	L187	EDWIN KLIMEK	KLIMEK RACING	08/18
271	07/21	TOM CROMPTON	KRYPTON RACING	96.046	MPS/CG-500	93.687	271	TOM CROMPTON	KRYPTON RACING	07/21
L1907	09/17	MIKE THIBEAULT	KNOW FEAR MOTORSPORTS	132.859	MPS/CG-650	135.102	L1907	MIKE THIBEAULT	KNOW FEAR MOTORSPORTS	09/17
9240	09/20	STEVE TOOTHAKER	BLACK KAT RACING	138.817	MPS/CF-750	142.501	9240	STEVE TOOTHAKER	BLACK KAT RACING	09/20
9240	09/20	STEVE TOOTHAKER	BLACK KAT RACING	147.907	MPS/CG-750	150.657	9240	STEVE TOOTHAKER	BLACK KAT RACING	09/20
L195	09/17	CHUCK SIM	SIMATOMIC RACING	135.571	MPS/CF-1000	137.883	L195	CHUCK SIM	BLACK KAT RACING	09/20
				146.741	MPS/CG-1000	150.817			SIMATOMIC RACING	09/17
ALTERED										
350	07/17	JOHN BENNETT	FIVEANDDIME RACING	115.686	A/CG-500	116.557	350	JOHN BENNETT	FIVEANDDIME RACING	07/17
9240	07/17	STEVE TOOTHAKER	BLACK KAT RACING	121.669	A/CF-750	121.360	9240	STEVE TOOTHAKER	BLACK KAT RACING	04/15
9240	09/15	STEVE TOOTHAKER	BLACK KAT RACING	129.745	A/CG-750	130.239	9240	STEVE TOOTHAKER	BLACK KAT RACING	09/15
408	09/20	BILL BULLIS	BULLIS RACING	152.556	A/CF-1000	156.410	408	BILL BULLIS	BULLIS RACING	09/20
408	09/21	WILLIAM BULLIS	BULLIS RACING	144.975	A/CG-1000	147.889	408	WILLIAM BULLIS	BULLIS RACING	09/21
7152	09/17	DONEL ROBERTS	WHITE BEARD RACING	139.094	A/CG-2000	142.310	7152	DONEL ROBERTS	WHITE BEARD RACING	09/17
ALTERED PARTIAL STREAMLINER										
9240	09/18	STEVE TOOTHAKER	BLACK KAT RACING	140.631	APS/CF-750	142.748	9240	STEVE TOOTHAKER	BLACK KAT RACING	09/18
SIDECAR										
1402	07/17	LLOYD FRINK SR	STERLING HILL GANG	87.432	SC/CF-1350	87.517	1402	LLOYD FRINK SR	STERLING HILL GANG	07/17
1402	07/17	LLOYD FRINK SR	STERLING HILL GANG	90.642	SC/CG-1350	89.177	1402	LLOYD FRINK SR	STERLING HILL GANG	07/17
1402	07/17	LLOYD FRINK SR	STERLING HILL GANG	86.691	SC/CBG-1350	89.961	1402	LLOYD FRINK SR	STERLING HILL GANG	07/17
1402	07/17	LLOYD FRINK SR	STERLING HILL GANG	89.280	SC/CBF-1350	90.116	1402	LLOYD FRINK SR	STERLING HILL GANG	07/17
ELECTRIC CATEGORY										
PURE PRODUCTION										
PRODUCTION										
MODIFIED										
197	09/21	TOM SCHAEFER	MYLAWVERTOM.COM	120.526	M/E-G	119.483	197	TOM SCHAEFER	MYLAWVERTOM.COM	09/21
197	09/21	TOM SCHAEFER	MYLAWVERTOM.COM	120.281	M/E-F	119.295	197	TOM SCHAEFER	MYLAWVERTOM.COM	09/21
197	09/21	TOM SCHAEFER	MYLAWVERTOM.COM	120.398	M/E-E	119.171	197	TOM SCHAEFER	MYLAWVERTOM.COM	09/21
197	09/21	TOM SCHAEFER	MYLAWVERTOM.COM	120.368	M/E-D	118.823	197	TOM SCHAEFER	MYLAWVERTOM.COM	09/21
197	09/21	TOM SCHAEFER	MYLAWVERTOM.COM	117.767	M/E-C	114.708	197	TOM SCHAEFER	MYLAWVERTOM.COM	09/21
197	09/21	TOM SCHAEFER	MYLAWVERTOM.COM	114.318	M/E-B	111.302	197	TOM SCHAEFER	MYLAWVERTOM.COM	09/21
197	09/21	TOM SCHAEFER	MYLAWVERTOM.COM	119.765	M/E-A	116.842	197	TOM SCHAEFER	MYLAWVERTOM.COM	09/21
197	09/21	TOM SCHAEFER	MYLAWVERTOM.COM	119.271	M/E-A2	117.807	197	TOM SCHAEFER	MYLAWVERTOM.COM	09/21
197	09/21	TOM SCHAEFER	MYLAWVERTOM.COM	118.813	M/E-A3	119.363	197	TOM SCHAEFER	MYLAWVERTOM.COM	09/21

VEH #	DATE	DRIVER	TEAM	1.0	CLASS	1.5	VEH #	DRIVER	TEAM	DATE
		MODIFIED PARTIAL STREAMLINER								
197	09/21	TOM SCHAEFER	MYLAWVERTOM.COM	119.956	MPS/E-G	118.922	197	TOM SCHAEFER	MYLAWVERTOM.COM	09/21
197	09/21	TOM SCHAEFER	MYLAWVERTOM.COM	120.751	MPS/E-F	119.740	197	TOM SCHAEFER	MYLAWVERTOM.COM	09/21
197	09/21	TOM SCHAEFER	MYLAWVERTOM.COM	120.564	MPS/E-E	118.860	197	TOM SCHAEFER	MYLAWVERTOM.COM	09/21
197	09/21	TOM SCHAEFER	MYLAWVERTOM.COM	119.868	MPS/E-D	120.006	197	TOM SCHAEFER	MYLAWVERTOM.COM	09/21
9942	07/18	FRANK JOHN	FJ RACING	157.392	MPS/E-C	158.004	9942	FRANK JOHN	FJ RACING	07/18
197	09/21	TOM SCHAEFER	MYLAWVERTOM.COM	117.938	MPS/E-B	119.166	197	TOM SCHAEFER	MYLAWVERTOM.COM	09/21
197	09/21	TOM SCHAEFER	MYLAWVERTOM.COM	119.291	MPS/E-A	116.799	197	TOM SCHAEFER	MYLAWVERTOM.COM	09/21
197	09/21	TOM SCHAEFER	MYLAWVERTOM.COM	116.235	MPS/E-A2	111.981	197	TOM SCHAEFER	MYLAWVERTOM.COM	09/21
9942	09/16	FRANK JOHN	FJ RACING	201.644	MPS/E-A3	206.847	9942	FRANK JOHN	FJ RACING	09/16
197	09/21	TOM SCHAEFER	MYLAWVERTOM.COM	120.496	MPS/E-A4	118.248	197	TOM SCHAEFER	MYLAWVERTOM.COM	09/21
197	09/21	TOM SCHAEFER	MYLAWVERTOM.COM	119.736	MPS/E-A5	118.568	197	TOM SCHAEFER	MYLAWVERTOM.COM	09/21
		ALTERED								
9942	07/22	FRANK JOHN	FJ RACING	74.742	A/E-H	72.706	9942	FRANK JOHN	FJ RACING	07/22
		ALTERED PARTIAL STREAMLINER								
343	09/18	FRANK JOHN	FJ RACING	156.074	APS/E-C	158.551	343	FRANK JOHN	FJ RACING	09/18
9942	08/19	FRANK JOHN	FJ RACING	149.807	APS/E-A	145.116	9942	FRANK JOHN	FJ RACING	08/19
2323	07/18	JEFF DISINGER	ELECTROFUNK RACING	182.680	APS/E-A2	175.679	2323	JEFF DISINGER	ELECTROFUNK RACING	07/18
9942	07/17	FRANK JOHN	FJ RACING	200.176	APS/E-A3	204.575	9942	FRANK JOHN	FJ RACING	07/17
		STREAMLINER			S/E-A6					
		SIDECAR								
		SIDECAR STREAMLINER								
1232	07/12	EVA HAKANSSON	KILLAJOULE RACING	164.131	SCS/E-349+	188.063	1232	EVA HAKANSSON	KILLAJOULE RACING	07/12

LORING TIMING ASSOCIATION

2-CLUB MEMBERS

NAME	SPEED	VEHICLE	DATE	BEST
3-CLUB MEMBERS				
BILL WARNER	311.945	OHC-MC	Jul-11	311.925

2-CLUB MEMBERS

PHILLIP C. CAMPBELL	222.359	OHC-MC	Aug-09	235.515
BILL WARNER	217.496	OHC-MC	Aug-09	311.945
TOM PETERSON	205.067	OHC-MC	Aug-09	214.387
RACHEAL JOHNSON	204.438	OHC-MC	Aug-09	228.322
DON HASS	228.478	OHC-MC	Aug-09	244.851
GUY CAPUTO	207.306	OHC-MC	Aug-09	223.602
JOE LEDFORD	208.613	ROADSTER	Aug-09	216.596
DOUG MEYER	208.623	OHC-MC	Aug-09	222.392
ALI ABABAKR	220.054	OHC-MC	Aug-09	229.621
SHANE STUBBS	240.590	OHC-MC	Aug-09	265.291
TODD DROSS	219.731	OHC-MC	Aug-09	240.057
DEAN SABATINELLI	220.647	OHC-MC	Aug-09	269.776
STEVE KNECUM	232.042	OHC-MC	Aug-09	248.467
BOB SELLERS	208.025	OHC-MC	Aug-09	214.005
SHANE BURTON	205.714	OHC-MC	Aug-09	211.974
MICHAEL COAKLEY	202.088	OHC-MC	Aug-09	215.786
T SCOTT JONES	203.082	OHC-MC	Aug-09	203.082
MARK DELUCA	224.606	OHC-MC	Aug-09	237.742
RANSOM HOLBROOK	205.648	OHC-MC	Aug-09	252.222
DEBBIE DROSS	218.150	OHC-MC	Aug-09	218.150
JIM GILNACK	215.801	OHC-MC	Aug-09	215.801
DOUG KENNY	202.047	ROADSTER	Aug-09	210.358
JIM CLEMENS	204.894	ALT COUPE	Aug-09	208.015
ROY BROOKS	202.821	OHC-MC	Aug-09	202.853
LARRY ILLINGSWORTH	202.935	ROADSTER	Aug-09	202.935
JOSH OWEN	228.038	OHC-MC	Aug-09	228.038
WILLIAM HOSLER	206.991	OHC-MC	Aug-09	208.487
DONNA TIMNEY	205.039	OHC-MC	Aug-09	205.039
GREG NEAL	202.110	OHC-MC	Aug-10	208.212
LUKE KOHLER	201.252	CLASSIC-ALT	Aug-10	201.252
FRANK WADDELL	206.469	ROADSTER	Aug-10	206.469
KEITH TURK	205.198	C-COUPE	Aug-10	205.198
DICK JURKOWSKI	200.919	C-COUPE	Aug-10	200.919
STEVE VAN BLARCOM	211.675	ROADSTER	Aug-10	218.374
BOB SELF	218.113	GT	Aug-10	218.113
DAVID FREIBURGER	213.457	CLASSIC-ALT	Aug-10	213.457
LARRY WADDELL	210.285	REAL STREET	Aug-10	210.285
MIKE BRAKEL	206.256	OHC-MC	Aug-10	225.301
JOHN UBERMUTH	205.615	OHC-MC	Aug-10	208.962
JOE TIMNEY	200.619	OHC-MC	Aug-10	200.619
TONYA TURK	208.097	CLASSIC-ALT	Aug-10	208.097

RON SAN GIOVANNI JR	208.690	ROADSTER	Aug-10	219.808
DAVID RUDAN, JR	217.517	GT	Aug-10	217.517
JOHN CIANCITTO	200.834	C-COUBE	Aug-10	200.834
GARY BEINEKE	208.478	CIRCLETRACK	Aug-10	209.478
DON BIGLOW	240.427	LAKESTER	Jul-11	247.545
BRIAN ACTON	203.449	ALT-COUBE	Jul-11	227.524
LAWSON BILHARDT	210.581	GAS COUBE	Jul-11	210.581
DAVID HAAS	208.490	CIRCLETRACK	Jul-11	212.716
CHARLES FREEMAN	212.063	OHC-MC	Jul-11	221.183
GEORGE TURNER	202.630	Alt-Coupe	Jul-11	202.630
JEFF JACOBS	202.311	PRODUCTION	Jul-11	202.868
PAM BEINEKE	205.700	CIRCLETRACK	Jul-11	251.137
KENT SIRIMOGLU	204.886	OHC-MC	Jul-11	220.017
JIM COSGROVE	206.882	LAKESTER	Jul-11	223.347
SCOTT HORNER	246.334	OHC-MC	Jul-11	246.334
FRED MULLAVER	203.592	PRODUCTION	Jul-11	203.592
RICKEY GADSON	200.764	OHC-MC	Jul-11	206.741
RICHARD GADSON	203.889	OHC-MC	Jul-11	210.814
TERRY RUSSELL	210.660	GAS COUBE	Jul-11	210.660
MARK GORDON	230.698	OHC-MC	Jul-11	232.901
THOMAS CRONAN	213.297	OHC-MC	Sep-11	262.161
CHARLES VENABLE	205.939	C-COUBE	Jul-12	213.624
KENT SIRIMOGLU	204.640	OHC-MC	Jul-12	220.017
DAVID MATYJASIK	205.428	C-COUBE	Jul-12	205.428
COLT BATEMAN	230.700	OHC-MC	Jul-12	235.777
DAN MILLHOLLAND	207.993	OHC-MC	Jul-12	207.994
DAVID BALL	205.041	OHC-MC	Jul-12	212.268
JIM CLEMENS	204.894	OHC-MC	Jul-12	208.015
FRED VANCE	203.050	OHC-MC	Jul-12	234.855
JENNIFER ROBINSON	227.965	OHC-MC	Jul-12	235.959
BRENDA SUE CARVER	216.764	OHC-MC	Jul-12	223.697
IAIN MACARTHUR	207.432	REAL STREET	Sep-12	219.916
BILL AMARAL	211.437	CLASSIC-ALT	Sep-12	216.531
RYAN OSTERGARD	216.658	OHC-MC	Jul-13	253.351
EDDIE POWELL	201.188	SC-MC	Jul-13	201.188
JACK ROGERS	201.037	ALT-COUBE	Jul-13	214.645
TRACY ROGERS	202.197	OHC-MC	Jul-13	219.023
GILLES CHIASSON	204.471	OHC-MC	Jul-13	217.552
JASON THERIAULT	207.203	SUPER STREET	Jul-13	214.152
GEORGE GALLIMORE	223.334	CLASSIC-GC	Jul-13	241.781
JODY PEREWITZ	202.719	PUSHROD-MC	Jul-13	202.945
DENNIS COSGROVE	204.473	LAKESTER	Jul-13	217.957
CARL THERIAULT	200.667	ALT-COUBE	Jul-14	223.676
EDWARD PETROZZI	232.513	OHC-MC	Jul-14	250.274
PETER CALAGUIRO	208.717	ALT-COUBE	Jul-14	216.572
RALPHIE NAVARRO	202.565	OHC-MC	Jul-14	220.448
GIUSEPPE MELARAGNO	202.026	OHC-MC	Jul-14	207.653
SAM HURWITZ	202.341	OHC-MC	Jul-14	212.135

RAY PAQUETTE	201.731	OHC-MC	Jul-14	209.281
SCOTT DAVIS	219.323	OHC-MC	Jul-14	266.553
ALEX MERRELL	200.869	OHC-MC	Sep-14	200.869
BREVON SCOTT	222.356	OHC-MC	Jul-15	251.816
MIKE REICHEN	200.137	SUPER STREET	Jul-15	200.137
DAVID THOMPSON	206.173	OHC-MC	Jul-15	230.641
HUSSAIN ALSOWAIGH	208.023	OHC-MC	Jul-15	255.624
ALFRED PIGGOTT	211.680	CIRCLE TRACK	Sep-15	211.788
JOHN OKALY	225.361	LAKESTER	Sep-15	250.758
SCOTT POLAND	232.868	OHC-MC	Sep-15	236.939
JENS HUNTER	202.580	OHC-MC	May-16	209.668
BEN KNIGHT	212.889	OHC-MC	May-16	227.358
JASON WHITE	209.100	GT	Jul-16	269.673
BOB KESELOWSKY	221.744	CIRCLE TRACK	Jul-16	261.273
DON WARREN	201.219	SUPER STREET	Jul-16	215.521
MARK DOTSON	200.649	OHC-MC	Jul-16	204.171
BOB JINKENS	208.699	STREAMLINER	Jul-16	236.761
DEREK TOTI	208.768	OHC-MC	Jul-16	228.382
RASHID AL-HAJRI	261.114	OHC-MC	Jul-16	261.114
ALAN MANES	200.610	OHC-MC	Sep-16	220.399
FRAN WHITE	217.924	GT	Sep-16	217.924
ED MANES	202.826	OHC-MC	Sep-16	209.020
FRANK JOHN	201.645	EV-MC	Sep-16	206.847
ADAM BURROWS	214.236	OHC-MC	Jul-17	233.636
PATRICK LESSARD	200.065	OHC-MC	Jul-17	200.065
FRED GIAIMO	203.419	OHC-MC	Jul-17	219.885
CALVIN SMITH	201.654	ROADSTER	Jul-17	201.654
JOHN SHIPLE	200.732	OHC-MC	Jul-17	212.129
JOSEPH DALY	200.931	OHC-MC	Jul-17	204.473
CLIFF DALY	201.830	OHC-MC	Jul-17	206.158
JACK BATEMAN	215.845	STREAMLINER	Sep-17	220.069
RON KESELOWSKI	204.420	MODIFIED STR	Sep-17	257.445
RANDY POOLE	203.874	GT	Sep-17	213.806
THOMAS POOLE	201.435	GT	Sep-17	201.435
KRIS POULIN	200.977	OHC-MC	Sep-17	210.461
THOMAS POOLE JR	201.123	GT	Sep-17	211.756
MARK WEILER	202.304	GAS COUPE	Jul-18	202.305
JEFF GENTRY	205.210	STREAMLINER	Jul-18	205.210
ERNEST CAISSIE	201.920	SUPERSTREET	Jul-18	201.920
RON SAN GIOVANNI	200.921	ROADSTER	Jul-18	200.921
DAVE AURAND	208.575	OHC-MC	Jul-18	213.031
JOE ROBINSON	204.130	OHC-MC	Jul-18	212.482
EDWARD FOY	235.286	OHC-MC	Jul-18	241.664
MIKE WILSON	206.387	GT	Jul-18	206.387
JAY BELL	202.200	GAS COUPE	Jul-18	202.704
GREG DRAKE	219.932	GAS COUPE	Jul-18	219.932
KIRK LEVONIAN	201.332	OHC-MC	Aug-18	215.696
BRIAN HUFFMAN	222.703	ALT-COUPE	Jul-19	242.866
CHAD DOWELL	204.486	GAS COUPE	Jul-19	224.713
ROBERT WILLIAMS	200.207	OHC-MC	Aug-19	216.677

MARK MAYBURY	201.049	GT	Aug-19	223.337
RJ GOTTLIB	225.515	CLASSIC ALT	Aug-19	256.268
TOM HAAS	206.855	LAKESTER	Aug-19	211.952
CONNIE CAISSIE	203.465	SUPER STREET	Aug-19	203.465
MICHAEL MAYBURY	209.307	REAL STREET	Aug-19	209.307
VINCE CORTER	211.863	OHC-MC	Sep-20	214.363
MICHAEL BROWN	204.135	LAKESTER	Sep-20	221.440
JEFF ARNETT	203.581	ROADSTER	Sep-20	203.581
MARCIA BARKER	202.192	MOD SPORT	Sep-20	209.305
RICHARD PROSSER JR	201.017	CIRCLE TRACK	Sep-21	237.663
PHILLIP JOHNSON	213.202	OHC-MC	Jul-22	215.060
CHRIS BURNS	216.884	OHC-MC	Jul-22	239.450
LANE WIGGERS	202.277	GAS COUPE	Jul-22	202.277
TODD WOODIN	203.911	GAS COUPE	Jul-22	203.911

APPENDIX I - FAA SECTION 7. SAFETYING

7-122. GENERAL. The word *safetying* is a term universally used in the aircraft industry. Briefly, safetying is defined as: "Securing by various means any nut, bolt, turnbuckle etc., on the aircraft so that vibration will not cause it to loosen during operation." These practices are not a means of obtaining or maintaining torque, rather a safety device to prevent the disengagement of screws, nuts, bolts, snap rings, oil caps, drain cocks, valves, and parts. Three basic methods are used in safetying; safety-wire, cotter pins, and self-locking nuts. Retainer washers and pal nuts are also sometimes used.

7-123. SAFETY WIRE..

a. There are two methods of safety wiring; the double-twist method that is most commonly used, and the single-wire method used on screws, bolts, and/or nuts in a closely-spaced or closed-geometrical pattern such as a triangle, square, rectangle, or circle. The single-wire method may also be used on parts in electrical systems and in places that are difficult to reach. (See figures 7-3 and 7-3a.)

b. When using double-twist method of safety wiring, .032 inch minimum diameter wire should be used on parts that have a hole diameter larger than .045 inch. Safety wire of .020 inch diameter (double strand) may be used on parts having a nominal hole diameter between .045 and .062 inch with a spacing between parts of less than 2 inches. When using the single-wire method, the largest size wire that the hole will accommodate should be used. Copper wire (.020 inch diameter), aluminum wire (.031 inch diameter), or other similar wire called for in specific technical orders, should be used as seals on equipment such as first-aid kits, portable fire extinguishers, emergency valves, or oxygen regulators

Caution: Care should be taken not to confuse steel with aluminum wire.

82

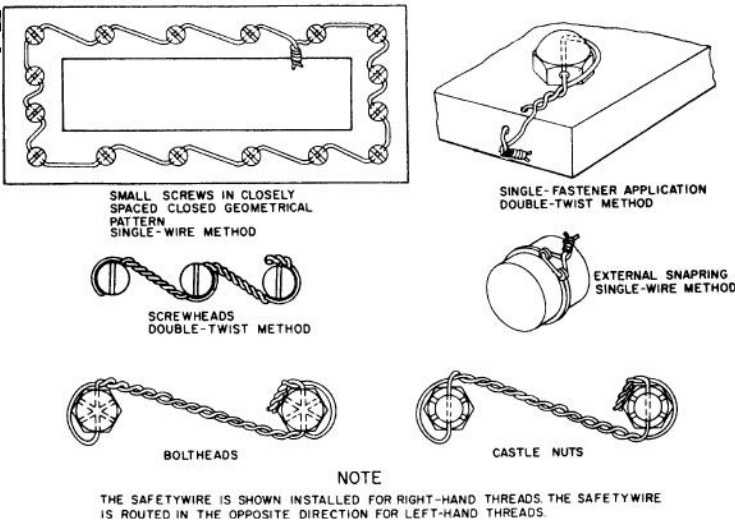
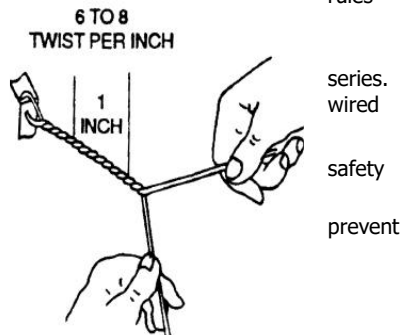

FIGURE 7-3. Securing screws, nuts, bolts, and snaprings.

7-124. SAFETY-WIRING PROCEDURES. There are many combinations of safety wiring with certain basic rules common to all applications. These are as follows.

- a.** When bolts, screws, or other parts are closely grouped, it is more convenient to safety wire them in series. The number of bolts, nuts, screws, etc., that may be together depends on the application.
- b.** To prevent failure due to rubbing or vibration, wire must be tight after installation.
- c.** Safety wire must be installed in a manner that will prevent the tendency of the part to loosen.



series.
wired
safety
prevent

d. Safety wire must never be over-stressed. Safety wire will break under vibrations if twisted too tightly. Safety wire must be pulled taut when being twisted, and maintain a light tension when secured. (See figure 7-3a.)

e. Safety-wire ends must be bent under and inward toward the part to avoid sharp or projecting ends, which might present a safety hazard.

(1) Check the units to be safety wired to make sure that they have been correctly torqued, and that the wiring holes are properly aligned to each other. When there are two or more units, it is desirable that the holes in the units be aligned to each other. Never overtorque or loosen to obtain proper alignment of the holes. It should be possible to align the wiring holes when the bolts are torqued within the specified limits. Washers may be used (see paragraph 7-37) to establish proper alignment. However, if it is impossible to obtain a proper alignment of the holes without undertorquing or overtorquing, try another bolt which will permit proper alignment within the specified torque limits.

(2) To prevent mutilation of the twisted section of wire, when using pliers, grasp the wires at the ends. Safety wire must not be nicked, linked, or mutilated. Never twist the wire ends off with pliers; and, when cutting off ends, leave at least four to six complete turns (1/2 to 5/8 inch long) after the loop. When removing safety wire, never twist the wire off with pliers. Cut the safety wire close to the hole, exercising caution.

f. **Install safety wire** where practicable with the wire positioned around the head of the bolt, screw, or nut, and twisted in such a manner that the loop of the wire fits closely to the contour of the unit being safety wired.

7-125. TWISTING WITH SPECIAL TOOLS. Twist the wire with a wire twister as follows. (See figure 7-4.)

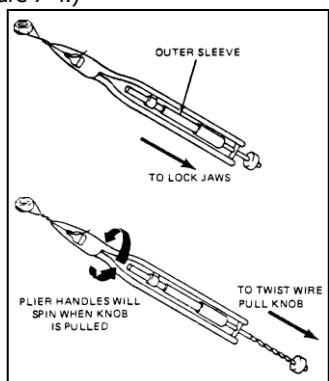

CAUTION: When using wire twisters, and the wire extends 3 inches beyond the jaws of the twister, loosely wrap the wire around the pliers to prevent whipping and possible personal injury. Excessive twisting of the wire will weaken the wire.

a. **Grip** the wire in the jaws of the wire twister and slide the outer sleeve down with your thumb to lock the handles or lock the springloaded pin.

b. **Pull** the knob, and the spiral rod spins and twists the wire.

c. **Squeeze** handles together to release **FIGURE 7-4.** Use of a typical wire twister.

wire.

7-126. SECURING OIL CAPS, DRAIN COCKS, AND

VALVES.

(See figure 7-4a.)

When securing oil caps and drain cocks, the safety wire should be anchored to an adjacent fillister-head screw. This method of safety wiring is applied to wingnuts, filler plugs, single-drilled head bolts, fillister-head screws, etc.; which are safety wired individually. When securing valve handles in the vertical position, the wire is looped around the threads of the pipe leading into one side of the valve, double-twisted around the valve handle, and anchored around the threads of the pipe leading into the opposite side of the valve. When castellated nuts are to be secured with safety wire, tighten the nut to the low side of the selected torque range, unless otherwise specified; and, if necessary, continue tightening until a slot lines with the hole. In blind tapped hole applications of bolts or castellated nuts on studs, the safety wiring should be in accordance with the general instructions of this chapter. Hollow-head bolts are safetied in the manner prescribed for regular bolts.

NOTE: Do not loosen or tighten properly tightened nuts to align safety-wire holes.

NOTE: Although there are numerous safety wiring techniques used to secure aircraft hardware, practically all are derived from the basic examples shown in figures 7-5 through 7-5b.

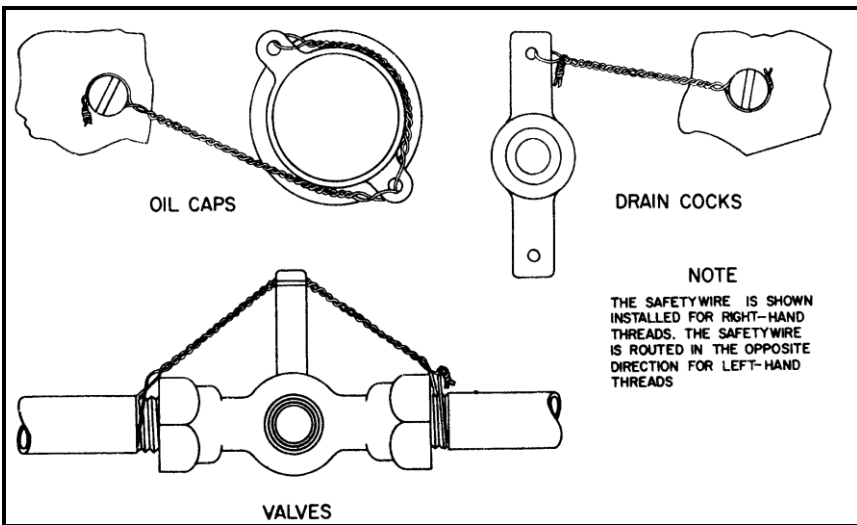

FIGURE 7-4a. Securing oil caps, drain cocks, and valves.

84



EXAMPLE 1



EXAMPLE 2



EXAMPLE 3



EXAMPLE 4

Examples 1, 2, 3, and 4 apply to all types of bolts, fillister-head screws, square-head plugs, and other similar parts which are wired so that the loosening tendency of either part is counteracted by tightening of the other part. Direction of twist from the second to the third unit is counterclockwise in examples 1, 3, and 4 to keep the loop in position against the head of the bolt. The direction of twist from the second to the third unit in example 2 is clockwise to keep the wire in position around the second unit. The wire entering the hole in the third unit will be the lower wire, except example 2, and by making a counterclockwise twist after it leaves the hole, the loop will be secured in place around the head of that bolt.



EXAMPLE 5



EXAMPLE 6



EXAMPLE 7

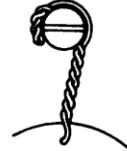

EXAMPLE 8

Examples 5, 6, 7, & 8 show methods for wiring various standard items, NOTE: Wire may be wrapped over the unit rather than around it when wiring castellated nuts or on other items when there is a clearance problem.



EXAMPLE 9



EXAMPLE 10



EXAMPLE 11

Example 9 shows the method for wiring bolts in different planes. Note that wire should always be applied so that tension is in the tightening direction. Hollow-head plugs shall be wired as shown with the tab bent inside the hole to avoid snags and possible injury to personnel working on the engine. Correct application of single wire to closely spaced multiple group.

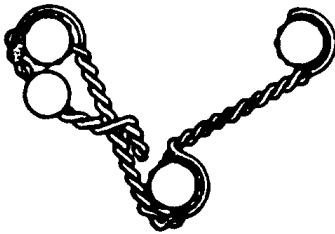

EXAMPLE 12

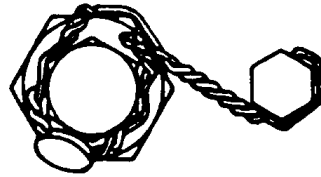

EXAMPLE 13

85

12 and 13 show methods for attaching lead seal to protect critical adjustments.



EXAMPLE 14



EXAMPLE 15



EXAMPLE 16

Example 14 shows bolt wired to a right-angle bracket with the wire wrapped around the bracket. Example 15 shows correct method for wiring adjustable connecting rod. Example 16 shows correct method for wiring the coupling nut on flexible line to the straight connector brazed on rigid tube.

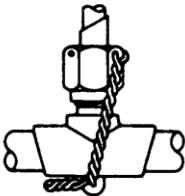

EXAMPLE 17



EXAMPLE 18

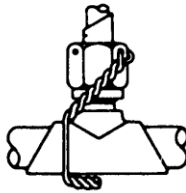

EXAMPLE 19



EXAMPLE 20

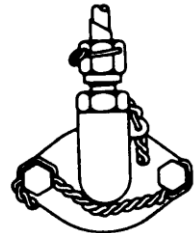

EXAMPLE 21

Fittings incorporating wire lugs shall be wired as shown in Examples 17 and 18. Where no lock-wire lug is provided, wire should be applied as shown in examples 19 and 20 with caution being exerted to ensure that wire is wrapped tightly around the fitting. Small size coupling nuts shall be wired by wrapping the wire around the nut and inserting it through the holes as shown.

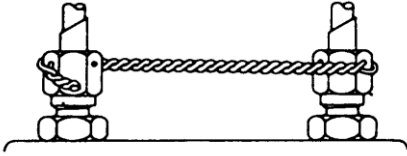

EXAMPLE 22

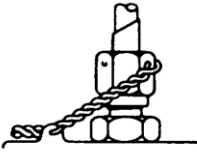

EXAMPLE 23

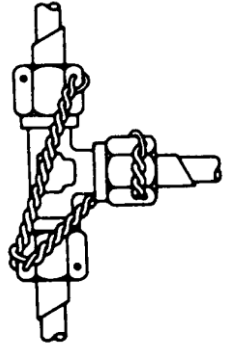

Coupling nuts attached to straight connectors shall be wired as shown, when hex is an integral part of the connector. Coupling nuts on a tee shall be wired, as shown above, so that tension is always in the tightening direction.

86

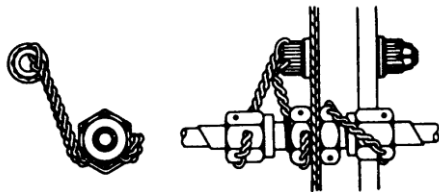

EXAMPLE 25

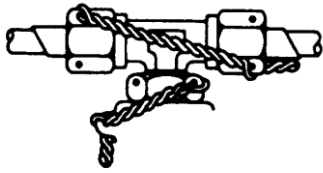

EXAMPLE 26

Straight Connector (Bulkhead Type)

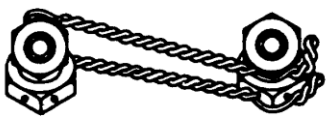

EXAMPLE 27

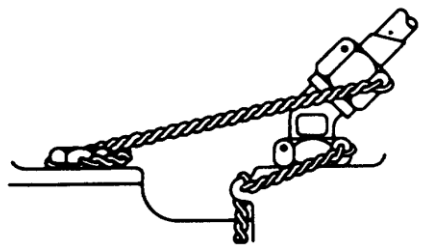

EXAMPLE 28

Examples 26, 27, and 28 show the proper method for wiring various standard fittings with checknut wired independently so that it need not be disturbed when removing the coupling nut.

7-127. SECURING WITH COTTER PINS.

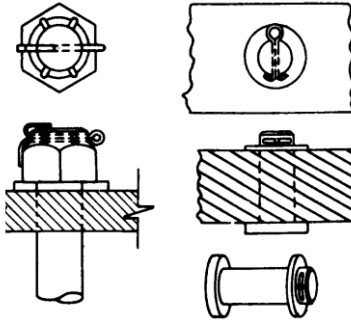

a. Cotter pins are used to secure such items as bolts, screws, pins, and shafts. Their use is favored because they can be removed and installed quickly. The diameter of the cotter pins selected for any application should be the largest size that will fit consistent with the diameter of the cotter pin hole and/or the slots in the nut. Cotter pins should not be re-used on aircraft.

b. To prevent injury during and after pin installation, the end of the cotter pin can be rolled and tucked.

FIGURE 7-6. Securing with cotter pins.

NOTE: In using the method of cotter pin safing, as shown in figures 7-6 and 7-7, ensure the prong, bent over the bolt, is seated firmly against the bolt shank, and does not exceed bolt diameter. Also, when the prong is bent over the nut, ensure the bent prong is down and firmly flat against the nut and does not contact the surface of the washer.

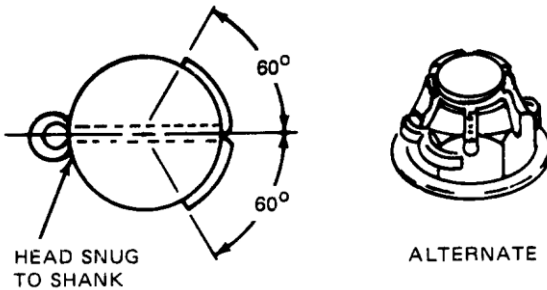

FIGURE 7-7. Alternate method for securing with cotter pins.



DELAWARE CHASSIS WORKS

Helping The Racer Since 1979

Hans Device

Head & Neck Restraints

Winters

Quickchange Rears & Parts

FIREFOX

Fire Suppression Systems

Stroud

Firesuits & Parachutes

Kestral 4000

Pocket Weather Tracker

Afco

Shocks & Radiators

Custom Axles

Moser Engineering • Strange Engineering

Ultra Shield

Full Containment Seats

Your Landspeed Connection

See Our Display at Ohio Mile & Bonneville

*Components To Complete Rides,
Race Cars, Hot Rods, Motorcycles
Metal Shaping & Fabrication*

Joe Timney (302) 378-3013

delawarechassisworks.com

Call:  Established 1977!

BRITISH CYCLE

40th Anniversary!

SUPPLY COMPANY

IMPORTERS AND DISTRIBUTORS OF
* ORIGINAL * REPLACEMENT * SPEED * CUSTOM *
PARTS AND ACCESSORIES FOR CLASSIC

TRIUMPH - BSA - NORTON MOTORCYCLES

50 CONNECTICUT ROAD, LORING COMMERCE CENTER
LIMESTONE, MAINE, USA 04750

USA Number: (201)880-0366

& 604 DAVISON STREET, RR3 WOLFFVILLE
NOVASCOTIA, CANADA B4P 2R3

Canada Number: (902)542-7478

Fax: (902)542-7479

www.britcycle.com info@britcycle.com

Warehouses in Canada and USA to serve you better!
Credit Card and prepaid orders shipped worldwide.
C.O.D. available in Canada and USA.

We support the sport!

*Please see our Web Site for the schedule of
our sponsored racer, Andrew Cowell!*

Performance parts exclusively for British Motorcycles:

Joe Hunt magnetos, Megacycle cams, belt drives,
R/D Valve Springs, Black Diamond Valves,
Carrillo Conrods, wide range of sprockets, racing seats,
stainless spokes, and much more...

Dealer enquiries invited!

LSR CHAIN GUARDS



9

ELECTRONICS



NITROUS KITS



R.I.P. Dave Owen

AND MUCH, MUCH MORE!



Tiger Racing
Tampa, FL 33618
TEL: 917-567-3972
Tiger.racing@bex.net



40% Less Friction vs. Steel
Less Friction = Horsepower

60% Less Rotating Weight

Lasts 3 to 5 times
Longer than Steel

Lower Vibration &
Cooler Running Conditions

Angie Smith

DENSO Buell

NHRA Pro Stock Motorcycle



800-575-3220

worldwidebearings.com

216 Little Falls Road #1, Cedar Grove, NJ 07009

**HYBRID CERAMIC
BEARINGS**

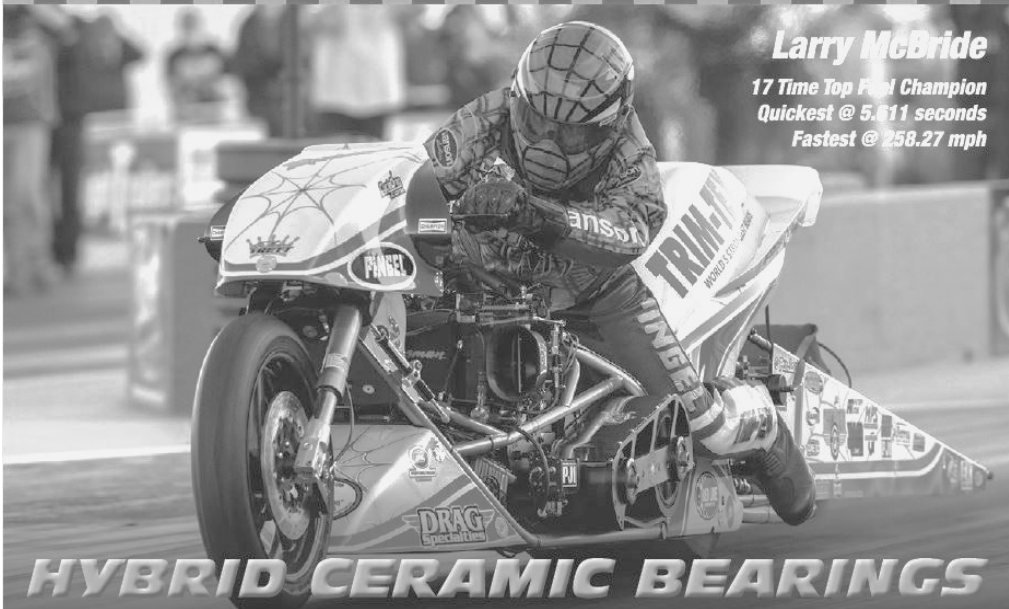

Larry McBride

17 Time Top Fuel Champion

Quickest @ 5.11 seconds

Fastest @ 258.27 mph

HYBRID CERAMIC BEARINGS

Vanson's Racing Suits

When making your run with either a motorcycle or car, we'll have you covered. Vanson has been providing protective racing suits since 1974. Hand made in the U.S.A.!

- Motorcycle Racing Leathers



Automotive Fire Suits -



Lowbrow Racing at the Bonneville Salt Flats

AirPro Airbag System

Want more protection?
Vanson's now offers an AirBag system for all types of motorcycle racing.



Handcrafted in U.S.A. for Over 47 Years
951 Broadway, Fall River, MA 02724
(508) 678-2000
vansonleathers.com

